



SHELVING | POINT OF SALE | SIGNAGE | CUSTOM DISPLAYS

SINCE 1974

SHOP FITTINGS GUIDE

si retail[®]
SOLUTIONS IN RETAIL

ABOUT US

At SI Retail our focus is to provide you with a range of shopfitting solutions suited to your exact needs. We study your brand and work with you to deliver effective methods of displaying your stock, advertising promotional products or just simply help you stand out from the crowd. With extensive industry knowledge, our professional team will work with you to scope out all the details in order to deliver the most effective solutions relative to your needs. Whether it be merchandising, displays, point of sale or custom design, we will find the perfect solution for your brand!

SI Retail is committed to giving our customers the best opportunities and the most holistic service possible. Although our family owned business has been operating in Australia since 1974, we established our own office in China in 2006 to focus on sourcing, manufacturing and shipping. Our bilingual Chinese team of designers, quality controllers, project coordinators, product buyers and logistics supervisors coordinate with our Australian industrial designers and project managers, giving us the unique ability to ensure the supply chain is fully controlled – from the start of your project through to its completion.

In 2019, we opened an office/showroom/warehouse facility in Melbourne as part of our expansion to better cater for our Victorian customers. This is complementary to our large Brisbane head office and warehouse which enables immediate deliveries direct to your stores.



BRISBANE HEAD OFFICE

85 Burchill Street,
Loganholme,
QLD 4129
PH: 07 3801 0000

OUR DIFFERENCE

- Australian Owned/Operated Since 1974
- Unrivalled Customer Service
- Expert Product Knowledge
- Quality Products at Affordable Prices
- Solution Based Approach
- Personalised Project Management
- Specialist Manufacturing Capabilities
- Visible Presence in China



MELBOURNE OFFICE

5 Scholar Drive,
Bundoora,
VIC 3083



SHANGHAI OFFICE

Room 1005, 58 Xin Yuan Road,
Anting, Jiading District,
Shanghai, CHINA 201805

CONTENTS

GONDOLAS & SHELVING	1-18
EZI-Q® In-Queue Merchandising System	1-6
Versa Gondolas	7-11
Versa & Classic Accessories	12
Classic Gondolas	13-16
Wallstrip	17-18
GONDOLA MERCHANDISING	19-24
EZI-GLIDE® Auto Facing Roller Shelves	19-20
DIVIDE-IT® Shelf Management	21-22
EZI-LED™ Shelf Lighting	23-24
DATA STRIPPING	25-30
Clip-On, Flat	25-26
Angled, Top Tape, Hanging	27
Bullnose, Jaw, Curve-It	28
Data Strip Accessories	29-30
DISPLAY HOOKS	31-39
Volcano Pegboard	31-32
Flat Metalboard	33
Slatwall	34
Grid Mesh	35-36
Specialty Hooks & Security Stop Locks	37
Crossbar Hooks & Arms	38
Display Hook Accessories	39
IMPULSE DISPLAYS	40-42
Bulk Goods Mobile Display, Dump Bins & Pallet Guard	40
Hand Sanitiser Station	41-42
SIGNAGE/POINT OF SALE	43-56
End-Signs™	44
Acrylic Signage	45-46
Sign Holders (Ticket Frames, Grips, Clips & Snap Frames)	47-50
Floor Stands (Catalogue Stands, Bulletin & Outdoor)	51-52
Counter/Checkout Point of Sale	52
Hanging Signage	53-54
Brochure Holders	55
Shopping Baskets	56
SLATWALL	57-62
Tower, Brackets, Signs, Shelves & Arms	58-59
Hangrails & Accessories	60
Slatbox Storage	61-62
GARMENT RACKS	63-64
Mobile Racks & Z-Rack	63
2-Way, 4-Way & Garment Rack Signage	64
CUSTOM CAPABILITIES	65-72

EZI-Q[®]

IN-QUEUE MERCHANDISING SYSTEM

Black in colour, the EZI-Q[®] merchandising system transforms wasted floor space into valuable additional retail space and helps increase profits per square meter by generating impulse sales from waiting customers.

An efficient in-queue merchandising system presents an opportunity for all retailers to maximise sales as it encourages customers to impulse buy and collect additional items on their way to the checkout. Whilst customers are queued, you have their full attention, time, and (soon) money, so reduce perceived wait times by distracting them with an effectively merchandised EZI-Q[®] system full of impulse products that the customer may have forgotten or may like to add to their basket.

This durable system can be fully customised and tailored to suit your store size and layout. The versatility of the EZI-Q[®] allows you to display numerous types of product and quickly adjust the displays to add more sections during peak trading periods or change it up for new seasons.





Custom colour 'white' shown
(Lead times & minimum order quantities apply)

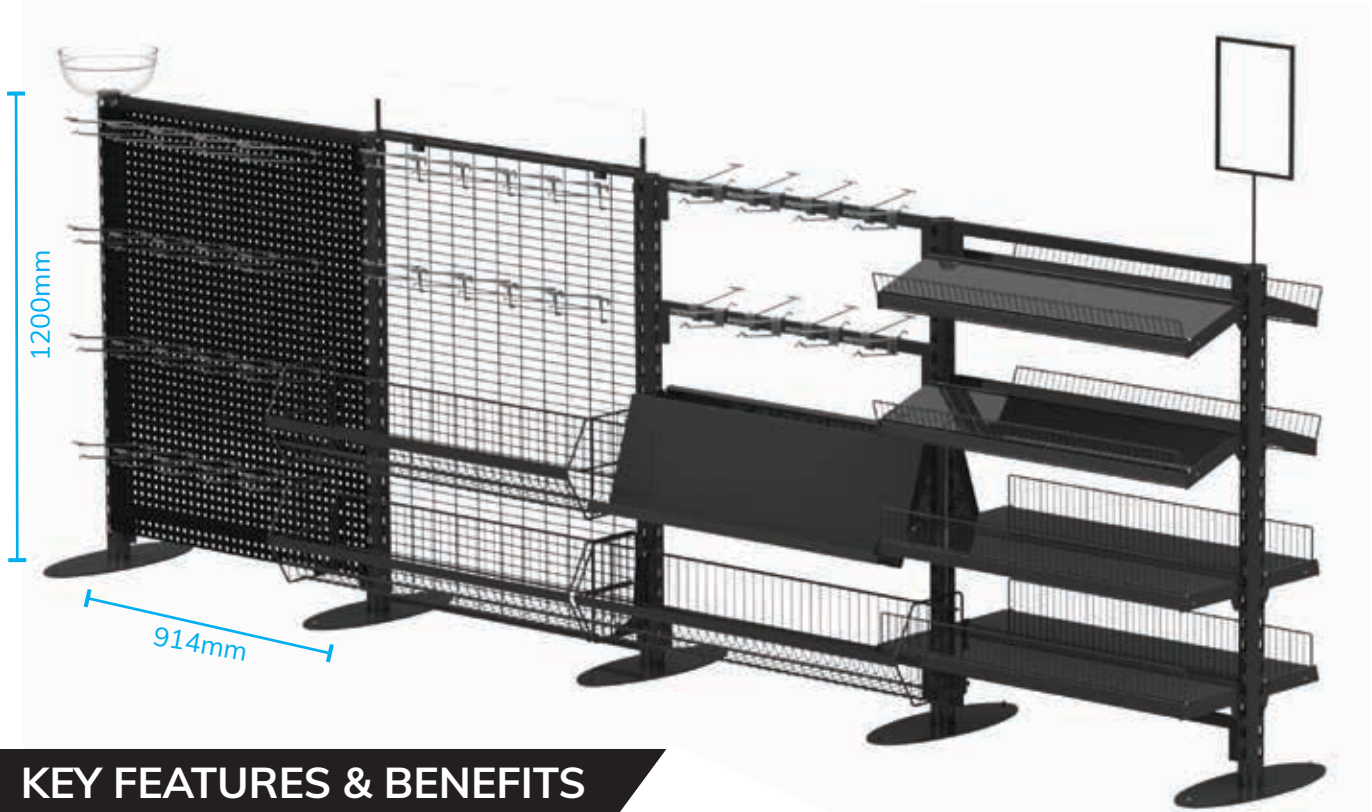

KEY FEATURES & BENEFITS

- Increases revenue from impulse sales.
- Strong and durable metal components.
- Lowers customers perceived wait times.
- Supports customer way-finding from entrance to exit.
- Stimulates a positive customer experience.
- Customisable and flexible to suit an array of products and store layouts.
- Stylish round posts are slotted on four sides enabling versatility in configurations.
- Tie bars join posts to ensure strength.
- Easy to install and reconfigure.
- Round base feet for corners and oval base feet for all other locations equate to a neatly presented and stable display for various products.
- Floor levelers are included with both round and oval base feet.

1. LAYOUT

- Each bay is 1200mm high x 914mm wide with connectable accessories to maximise product exposure. Consider your store layout and available space.
- Map out the best configuration (using the dimensions above) to suit this space.
- Work out how many bays you require then plan what products you wish to advertise on each bay and make a note of the best panel backings to suit these items.
- Ensure your configuration guides customers to the check-out with ease and items are strategically placed to entice your customer as they move through the queue.

2. BAY CONTENTS

- Begin with a **START BAY** (2 posts and 2 base feet) in your choice of panel style:

- A Hangsell (Includes 2 x Tie Bars),
- B Mesh or
- C Volcano Pegboard

OR build feet, posts and panels individually using the main components.

- Next, join **ADD-ON BAYS** or **CORNER BAYS** (1 post and 1 base foot each) to build and customise your queue.
- Add extra tie bars (QM-TB) or crossbars (QM-CB) to a hangsell bay (A) to display a full bay of hanging products.
- Finally, add display hooks relative to the panel style you have chosen (for all areas you wish to display hangsell product). View our range of display hooks and hook accessories on pages 31-39.

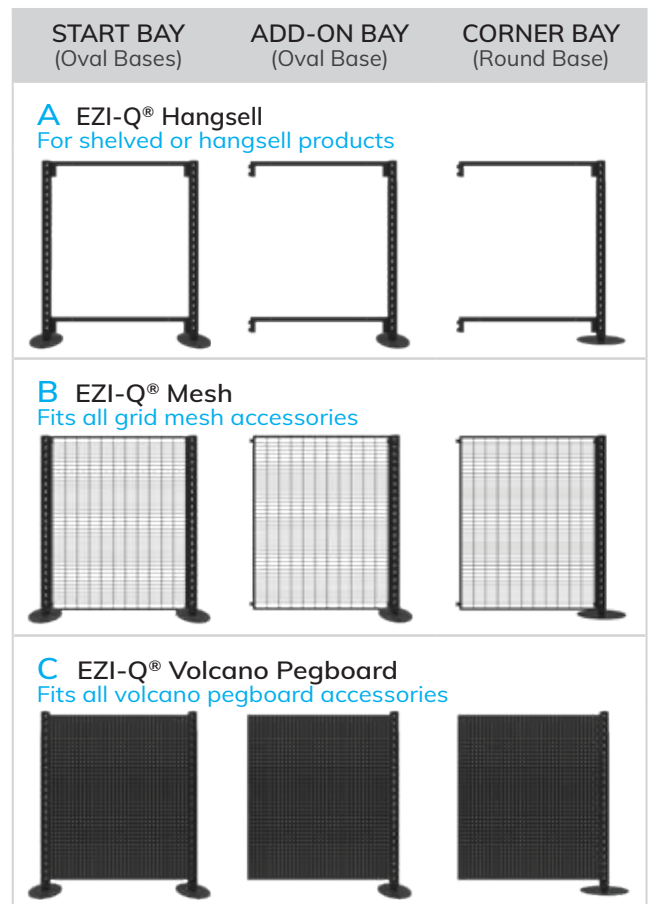

3. MIX 'N MATCH ACCESSORIES

Take advantage of the versatile functionality of the EZI-Q® system and build it to suit your planograms or simply merchandise both sides of each panel for high impact.

Shelf Options

- Flat or Angled Shelf
- Magazine Rack
- Wire Basket

Display Hooks

- Tie Bar or Crossbar Hooks
- Grid Mesh Single Prong or Flip Scan
- Pegboard Single Prong or Flip Scan

Signage

- A4 Metal Sign Holder
- Metal Stem (Suits T-Piece & Coloured Ticket Frames)
- Horizontal Sign Holder

Display Accessories

- Acrylic Bowl
- Crossbar or Tie Bar
- Hand Sanitiser Cradle

MAIN COMPONENTS

UPRIGHT 4-WAY POST

QM-U

Posts can be purchased separately to add onto an exiting EZI-Q® system. Slots on four sides of each post allows for custom layout configurations in any of the four directions.

Colour	■ Black
Size (mm)	1200 H x 60 Diameter



BASE FEET FOR POST

QM-F

Round feet are used when creating a corner, they tuck away out of sight whilst oval feet are used in all other locations for maximum stability. Both styles include floor levelers.

Colour	■ Black
Round Size (mm)	300 Diameter
Oval Size (mm)	500 L x 200 W

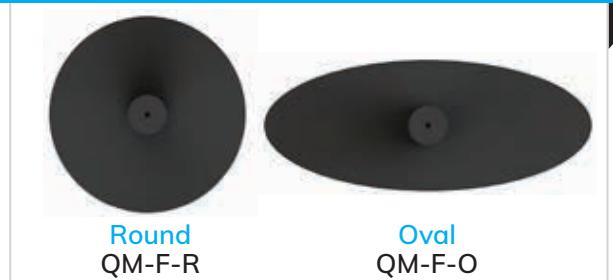

BACKING PANELS 914mm WIDE

QM-VP (Peg) & QM-WM (Mesh)

Colour	■ Black
Volcano Pegboard Sizes (mm)	300 & 400 H x 914 W
Wire Mesh Size (mm)	1200 H x 914 W

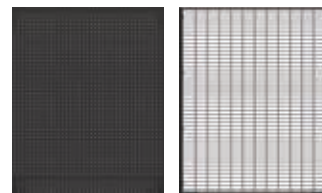

See pages 31-32 for pegboard hooks and 35-36 for grid mesh hooks

12mm MERCHANDISING BARS

QM-TB & QM-CB

Tie bars are used to join two posts without the need for any backing panels. Connect one across the bottom of your post and one across the top. Place crossbars in-between to maximise available hangsell space.

Colour	■ Black
Size of Both (mm)	12 W x 914 L



See page 38 for bar hooks

Tie Bar
QM-TB

Crossbar
QM-CB

FLAT METAL SHELF WITH BRACKETS

QM-SF-914-T

Strong metal shelf with angled front face and adjustable brackets. Shelf accepts wire fence or acrylic risers, perfect when positioning the shelf on an angle.

Colour	■ Black
Shelf Size (mm)	914 L x 200 D
Bracket Angles	0° or 20°



Suits **Clion**[®]
DATA STRIPS

EZI-Q® ACCESSORIES

GAP COVER FOR SHELVES

Sits in-between two adjacent shelves to cover the gap and create one large shelf. This ensures product doesn't fall off the back of shelves.

Colour	<input checked="" type="checkbox"/> Black
Width (mm)	914
Depth (mm)	60

QM-GC



CLEAR SHELF RISER

Colour	<input type="checkbox"/> Clear
Size (mm)	902 (For 914mm Shelves) x 6 Thick
Riser Height (mm)	90 (70mm Visible Height)

GD-V-RF6

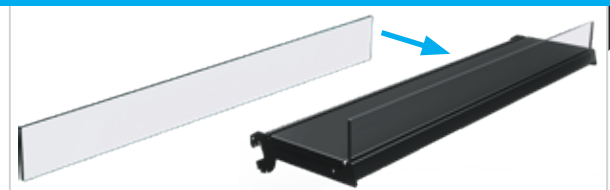

WIRE FENCE & DIVIDERS

Colour	<input checked="" type="checkbox"/> Black
Fence Size (mm)	902 L x 95 H x 6 Thick (75mm Visible Height)
Divider Size (mm)	200 L x 95 H x 6 Thick
Suits	Flat Metal Shelves 914mm L x 200mm D

QM-FNC & QM-V-DIV

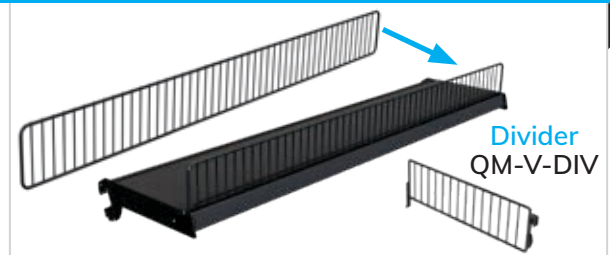

HAND SANITISER CRADLE & SIGN

NEW Hand sanitiser cradle with sign holder (see full sanitiser station on pages 41-42). Cradle holds rectangular, oval or round pump bottles with an approximate volume of 500ml.

Cradle/Frame Colour	<input type="checkbox"/> White
Cradle Size (mm)	116 W x 139 D x 164.5 H
Kit Includes	A4 ticket frame with sanitiser sign, white T-piece & wire sanitiser cradle

FD-SANKIT-HDSH-WT-T

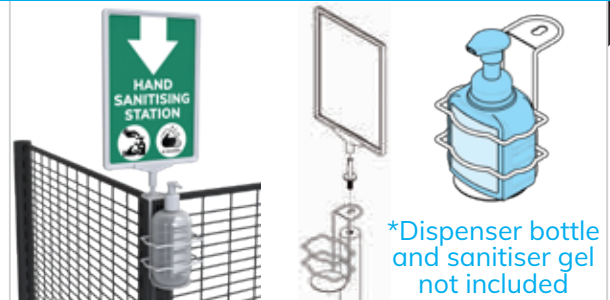

MAGAZINE RACK

Colour	<input checked="" type="checkbox"/> Black
Shelf Size (mm)	914 L x 300 H x 100 D
Bracket Angles	From the Vertical Post: 17°, 33°, 53°

QM-SF-MAG



WIRE BASKET

QM-WB

A large wire basket for holding a variety of loose items. Separate items with the basket divider below for more segmentation.

Colour	 Black
Basket Size (mm)	914 L x 250 D x 250 H



Suits  DATA STRIPS

WIRE BASKET DIVIDERS

QM-WB-DIV

Suits wire basket above and is used to separate items for easy accessibility. Wire basket also fits 914mm wide Versa gondolas.

Colour	 Black
Divider Size (mm)	250 D x 250 H

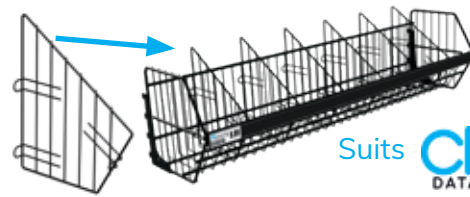

Suits  DATA STRIPS

ACRYLIC BOWL

QM-AB-230-CL-T

Includes bowl, bolt and 2 x mounting washers (small & large). Place the small washer on the base inside of the bowl and large washer under the bowl. Then use the bolt supplied to securely affix the acrylic bowl into the post.

Colour	 Clear
Diameter (mm)	230
Height (mm)	110



METAL SIGN HOLDER / METAL STEM

QM-SH & QM-TF-STEM

The EZI-Q® metal sign holder is produced as one welded piece with the frame attached. For different sized or coloured ticket frames, the stem can be purchased as a separate item (SKU: QM-TF-STEM). See pages 47-48 for ticket frames and accessories.

Colour	 Black
Metal Frame Size	A4 Portrait
Stem Size (mm)	240 H x 10 Diameter

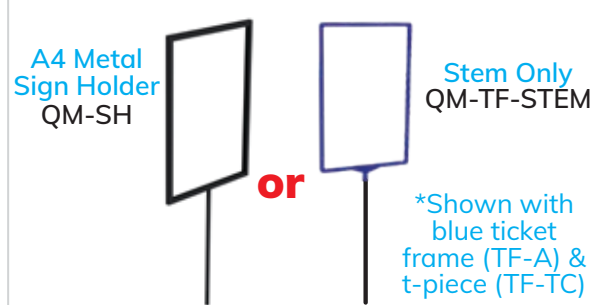

HORIZONTAL SIGN HOLDER

QM-TSH (600) / GD-V-TSH (850)

Colour	 Black
Size (mm)	600, 850 L (Sides of frame 85 high)
Artwork Size (mm)	599 / 849 L x Your choice of height (image shows sign at 150 high) x 8mm max thickness corflute/PVC, with 15mm internal margin at base



Acrylic artwork protectors (shown in image) are 150mm high and available separately QM-TSH-600-A150 / GD-V-TSH-850-A150

VERSA GONDOLAS

The most versatile, premium, heavy-duty shelving system in the market!

Thick reinforced steel shelves with added support gussets achieve a weight load rating upwards of 150kg per shelf*



Mix 'n match backing panels on the same bay

Optional roll out drawers



*Approximate weight load based on Versa 350mm shelf and bracket. For full weight load recommendations, please refer to the 'Versa Recommended Weight Loading' specification document which can be supplied upon request.

REAR PANELS

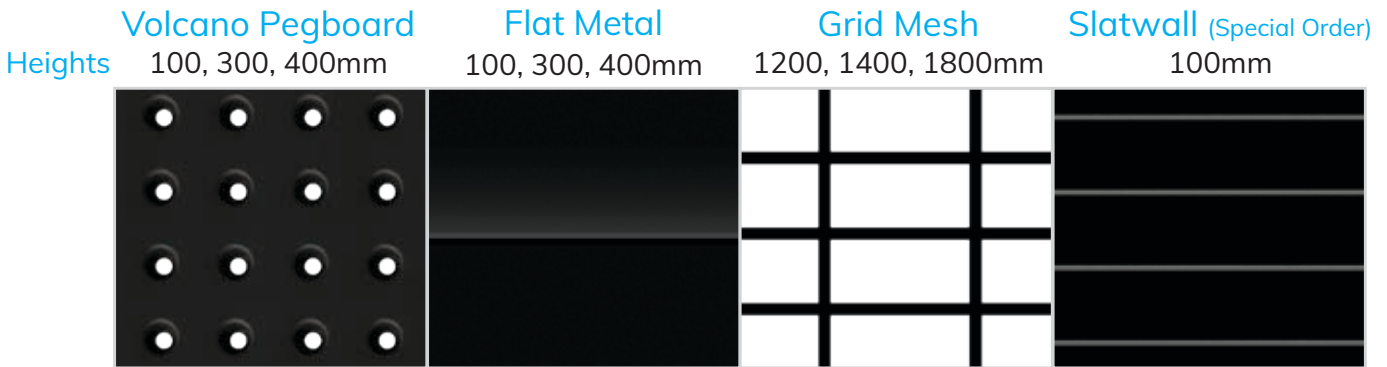

KEY FEATURES

CONSTRUCTION

- Made from **premium grade steel** with a **50mm pitch** on upright posts.
- Kits are available with your choice of height, width, rear backing panels (**volcano pegboard, slatwall, flat metal or grid mesh**) and base shelf height/depth. Add brackets and shelves separately.
- The unique volcano pegboard design **supports heavy loads** on pegboard hooks without deflecting.

VERSATILITY

- Choose different height feet on the same double sided gondola or customise your display by combining different panel styles within the same bay.
- Accessories include **top covers, shelf risers, base drawers, horizontal/hanging signage or LED lights!** PLUS Versa gondolas also fit EZI-Q® accessories such as **wire baskets and magazine racks**.
- Other colours or sizes can be ordered (lead times and minimum order quantities apply).

SHELVES

- Two types of shelves (**wire or flat metal**).
- 300-370mm shelves feature one support gusset whilst 400mm shelves (and larger) utilise **two support gussets for extra strength**.
- Versa shelf brackets allow shelves to be positioned flat or on **one of two angles!** 10° or 20°.
- Both shelf types cater for optional **clear front risers** to be inserted. Flat metal shelves also allow for optional **wire fences**.
- Risers and fences stop products falling forward whilst maintaining an **unobstructed view of the product**; perfect when positioning shelves on various angles.
- Versatile flat metal shelves feature an **angled front edge** (for better data strip visibility).
- Special **Clip-On data strips** (pages 25 & 26) will fit both wire and flat metal shelves.

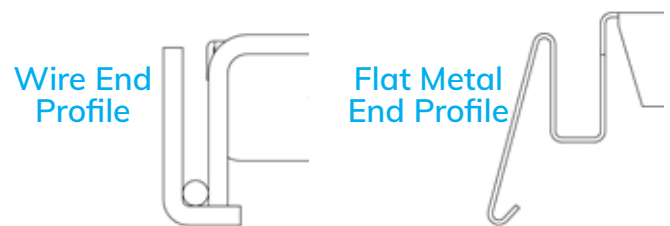

MAIN COMPONENTS

GONDOLA BAYS

GDV

Components	Start Bay (Also End Bay), Add-On Bay		
Configurations	Single Sided, Double Sided		
Colour	<input checked="" type="checkbox"/> Black	<input type="checkbox"/> White	<input type="checkbox"/> Grey
Rear Panels	Grid Mesh	Volcano Pegboard, Flat Metal	
Heights (mm)	1400 (Black), 1500, 1800, 2100	1200, 1400 (Black), 1500, 1800, 2100, 2400	1200, 1500, 1800, 2100, 2400
Bay Widths (mm)	914	600 (White), 914, 1200	914, 1200
Base Depths (mm)	350, 400, 450		370, 470
Base Heights (mm)	160, 260		160

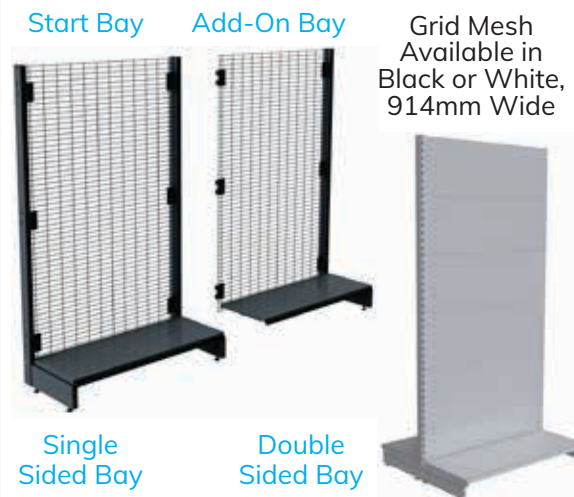

VERSA COMPONENTS

GONDOLA END CAP

GD-V-E

Colour	<input checked="" type="checkbox"/> Black	<input type="checkbox"/> White	<input type="checkbox"/> Grey	
Rear Panel	Volcano Pegboard			
Heights (mm)	1400, 1500	1400	1500	1500
Widths (mm)	740, 914	740	740, 914	914

Easily installed with only one screw using SI Retail's unique mounting system



UPRIGHT POSTS & EXTENSIONS

GD-V-U

Colours	<input checked="" type="checkbox"/> Black	<input type="checkbox"/> White	<input type="checkbox"/> Grey
Upright Heights (mm)	1200, 1400, 1500, 1800, 2100	1500, 1800, 2100	
Possible Heights with Extension (mm)	1700, 2400, 2700	2400	
Extension Size (mm)	300 H x 60 W x 30 L		
Extension Use	Extending the height of a gondola by 300mm. E.g. 1400mm upright + 300mm extension = 1700mm H bay		

Extension
GD-V-UE

Upright
GD-V-U



Please note that only 1 x extension is recommended per upright

BASE FEET

GD-V-L-S

Colours	<input checked="" type="checkbox"/> Black	<input type="checkbox"/> White	<input type="checkbox"/> Grey	
Lengths (mm)	350, 400, 450	300	350, 400, 450	370, 470
Heights (mm)	160, 260	160	160, 260	160
Use For	160: Maximising shelf space or to add front kick plates 260: Easier floor cleaning or to utilise base drawers			

160mm



260mm

FRONT KICK PLATES

GD-V-FM (100) / GD-V-KP (200)

Colours	<input checked="" type="checkbox"/> Black	<input type="checkbox"/> White	<input type="checkbox"/> Grey	
Lengths (mm)	914, 1200	600	914, 1200	914, 1200
Heights (mm)	100, 200	100	100, 200	100

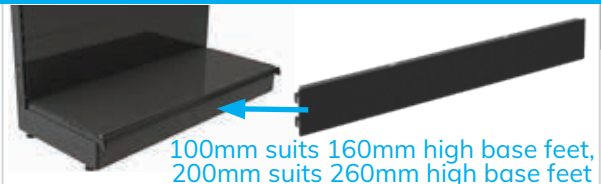

100mm suits 160mm high base feet, 200mm suits 260mm high base feet

ROLL OUT BASE DRAWER

GD-V-USD

Colours	<input checked="" type="checkbox"/> Black	<input type="checkbox"/> White	<input type="checkbox"/> Grey
Lengths (mm)	914, 1200	1200	1200
Height (mm)	210 (Sits Under 260 H Base Feet)		
Depth (mm)	340 (Suits 350 D or Larger Base Shelf)		



METAL SHELVES

GD-V-SF-M

Colours	Black			White			Grey
Shelf Lengths (mm)	740	914	1200	600	740	914	914
Shelf Depths (mm)	300	200					
		300	300	300	300	300	
		350	350	400		350	370
		400	400	450		400	470
		450	450		450	450	470



METAL SHELF BRACKETS

GD-V-BS-M

Colours	Black	White	Grey
Bracket Style	2 Lug	3 Lug	2 Lug
Shelf Depths (mm)	200, 300	350, 400, 450	370, 470
Tilt Angles	0° or 20°	0°, 10° or 20°	0° or 20°

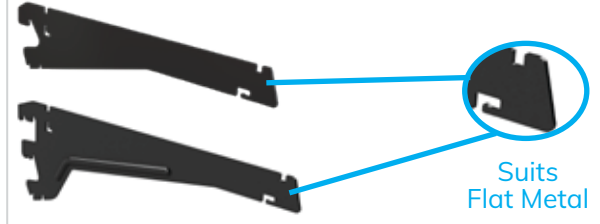

WIRE SHELVES

GD-V-SF-W

Colour	Zinc	
Shelf Lengths (mm)	740 (For End Caps)	914
Shelf Depths (mm)	250, 350	350, 450

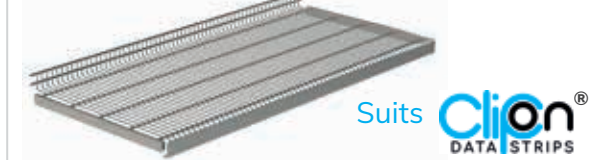

WIRE SHELF BRACKETS

GD-V-BS-W

Colours	Black	White
Bracket Style	2 Lug	3 Lug
Shelf Depths (mm)	250	350, 450
Tilt Angles	0° or 20°	0°, 10° or 20°

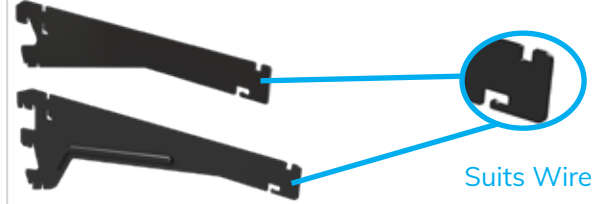

MAGAZINE RACK

QM-SF-MAG

Colour	Black
Shelf Size (mm)	914 L x 300 H x 100 D
Bracket Angles	From the Vertical Post: 17°, 33°, 53°



WIRE BASKET & DIVIDERS

QM-WB

Colour	Black
Basket Size (mm)	914 L x 250 D x 250 H
Divider Size (mm)	250 D x 250 H



CLEAR SHELF RISERS

Colour	<input type="checkbox"/> Clear		
Lengths (mm)	914, 1200		
Thickness (mm)	3 (For Wire Shelves)		6 (For Flat Metal Shelves)
Riser Heights (mm)	90	120	90
Visible Heights (mm)	70	100	70

GD-V-R

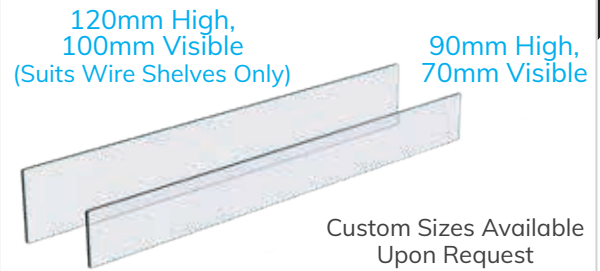

WIRE FENCES & DIVIDERS

Colour	<input type="checkbox"/> Chrome		
Suits	Flat Metal Shelves (GD-V-SF-M)		
Fence Lengths (mm)	914, 1200		
Fence Heights (mm)	95 (75 Visible), 170 (150 Visible)		
Divider Lengths (mm) (Suits Shelf Depths)	200, 300, 350, 370, 400, 450, 470		
Divider Height (mm)	95		

GD-V-FNC / GD-V-DIV

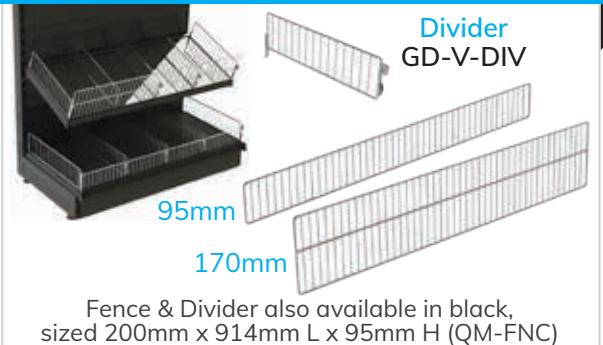

TOP COVERS

Colours	<input checked="" type="checkbox"/> Black	<input type="checkbox"/> White	<input type="checkbox"/> Grey
Lengths (mm)	600 (White), 914, 1200		
Width (mm)	60		
Styles	Standard (GD-V-TC) or Sign Holder Version (GD-V-SHTC)		

GD-V-TC / SHTC



HORIZONTAL SIGN HOLDER

Colours	<input checked="" type="checkbox"/> Black	<input type="checkbox"/> White	<input type="checkbox"/> Grey
Attaches To	Sign Holder Top Covers (GD-V-SHTC), End Caps or Grid Mesh		
Size (mm)	850 L (Sides of frame stand 85 high)		
Suits Bays (mm)	914mm Wide		
Artwork Size (mm)	849 L x Your choice of height (image shows sign at 150 high) x 8mm max thickness corflute/PVC, with 15mm internal margin at base		

GD-V-TSH



HANGING CATEGORY IDENTIFIER

Colour	<input checked="" type="checkbox"/> Black
Fittings (To Suit)	Gondola Bay (60) or End Cap (30)
Total Size (mm)	500 L x 330 H
Artwork Size (mm)	360 L x 200 H

GD-V-SH-L



VERSA & CLASSIC GONDOLA ACCESSORIES

LED LIGHT BOX

Gondola light boxes are a popular addition to the top of shelving. SI Retail use high quality LED's to light up your product branding. Available in set gondola sizes or custom made-to-order, your store will look fantastic with the addition of light boxes.

Colours	<input type="checkbox"/> White	<input checked="" type="checkbox"/> Black
Code (SKU)	GD-C-LB	GD-V-LB
Size (mm)	300 H x 1200 W x 30 Deep	
Lengths (mm)	900 & 914 (Made To Order), 1200	
Includes:	Light Box, Clear Cover and Brackets	

GD-C-LB / GD-V-LB

Use 1 x LED driver per 2 x Light boxes (sold separately GD-C-LB-TF12V5A)



12mm CROSSBARS

Colours	<input type="checkbox"/> Chrome	<input checked="" type="checkbox"/> Black
Lengths (mm)	914, 1200	914
Tube Size (mm)	32 H x 12 W	
Use With	Crossbar Hooks or Arms (Page 38)	

GD-R12 / QM-CB914-BK



HANGRAILS

Colour	<input type="checkbox"/> Chrome
Lengths (mm)	914, 1200
Size (mm)	300 D x 32 H x 12 W

GD-HR12



WIRE BASKET KIT

Colour	<input type="checkbox"/> Grey
Size (mm)	1200 L x 250 H x 450 Deep
Kit Inclusions	1 x Wire Basket, 5 x Dividers, 2 x Brackets

GD-V-WBKIT



UPRIGHT POST WALL BRACKET

Colour	<input type="checkbox"/> Zinc
Length (mm)	40
Width (mm)	40

GD-V-WFB



CLASSIC GONDOLAS

The perfect shelving system for most retail outlets.
Designed with slimline brackets and neat shelf edges.



KEY FEATURES

- Made from **premium grade steel**.
- Powder coated white.
- Available with your choice of either **volcano metal pegboard** or **flat metal rear panels**.
- Unique volcano pegboard designed to **withstand deflection from heavy loads** on pegboard hooks.
- Streamlined **0.6mm classic series shelves** to support general merchandise for most industries. **No protruding edges** ensures a clean display.
- **Feet are supplied separate to uprights** (achieving savings in freight).
- **Slimline** brackets concealed underneath the shelves blend in for optimal visibility of product.
- Kits are available with your choice of **height, width, backing panels** and **base shelf depth**. Add brackets and shelves separately.
- Customise your display with a variety of accessories including **top covers, front kick plates, wall brackets, wire baskets, shelf risers, drawers, sign holders** or **LED lights!**

REAR PANELS

	Volcano Pegboard	Flat Metal
Heights	100, 300, 400mm	100, 300, 400mm



Volcano Pegboard

Flat Metal



MAIN COMPONENTS

Single Sided or End Bay	Double Sided Bay	End Cap

GONDOLA BAY

Colour	<input type="checkbox"/> White
Rear Panels	Volcano Pegboard, Flat Metal
Components	Start Bay (Also End Bay), Add-On Bay
Configurations	Single Sided, Double Sided
Heights (mm)	1500, 1800, 2100, 2400
Bay Widths (mm)	600, 900, 1200
Base Depths (mm)	250, 300, 400
Base Heights (mm)	160, 260

GDC

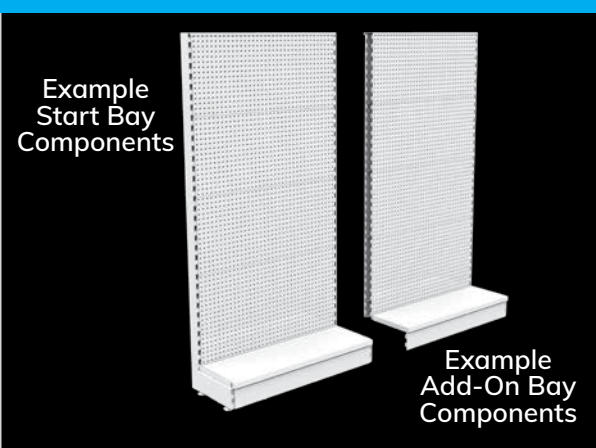

END CAP

Colour	<input type="checkbox"/> White
Rear Panel	Volcano Pegboard
Heights (mm)	1500, 2100
Width (mm)	600

GD-C-E-VP

Easily installed with only one screw using SI Retail's unique mounting system



CLASSIC ACCESSORIES

CLASSIC SERIES SHELVES

GD-C-SF

Colour	<input type="checkbox"/> White			
Material	Flat Metal			
Shelf Widths (mm)	600, 900, 1200			
Shelf Depths (mm)	200	250	300	400
Support Gussets	1		2	

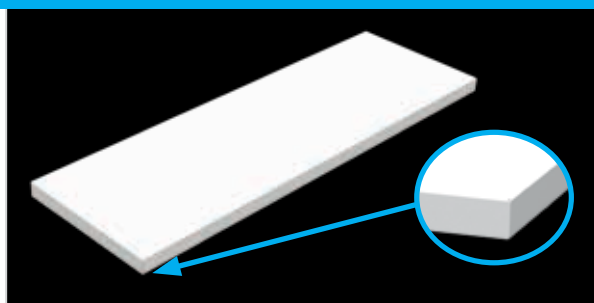

SHELF BRACKETS

GD-C-SB

Colour	<input type="checkbox"/> White	
Suits Shelf Type	Flat Metal	
Lengths (mm)	200, 250, 300	400
Tilt Angles (degrees)	0° (Flat), 20°	0° (Flat), 10°, 20°



UPRIGHT POSTS & EXTENSIONS

GD-C-U

Colour	<input type="checkbox"/> White	
Upright Heights (mm)	1500, 2100	
Possible Heights with Extension (mm)	1800, 2400	
Extension Size (mm)	300 H x 60 W x 30 L	
Use For	Extending the height of a gondola by 300mm. E.g. 1500mm upright + 300mm extension = 1800mm H bay	

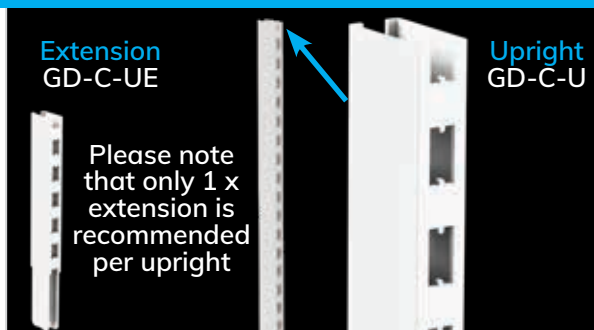

HORIZONTAL SIGN HOLDER

GD-C-SH

Colour	<input type="checkbox"/> White	
Attaches To	Sign Holder Top Covers (GD-C-SHTC), End Caps	
Height (mm)	Sides of frame stand 85 high	
Lengths (mm)	600	850
Suits Bays (mm)	600 Wide	900 & 1200 Wide
Artwork Length (mm)	599	849
Artwork Size (mm)	Your choice of height (image shows sign at 150 high) x 8mm max thickness corflute/PVC, with 15mm internal margin at base	



TOP COVERS

GD-C-TC / SHTC

Colour	<input type="checkbox"/> White
Lengths (mm)	600, 900, 1200
Width (mm)	60
Styles	Standard (GD-C-TC) or Sign Holder Version (GD-C-SHTC)

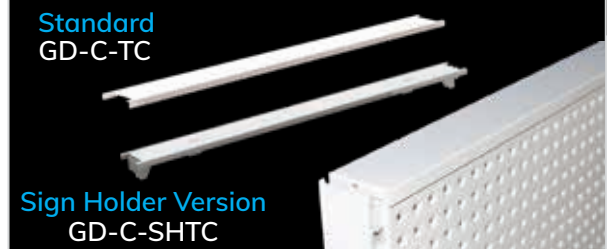

BASE FEET

GD-C-L

Colour	<input type="checkbox"/> White	
Lengths (mm)	250, 300, 400	
Heights (mm)	160	260
Use For	Extra shelf space and front kick plates	Easier floor cleaning or to utilise base drawers

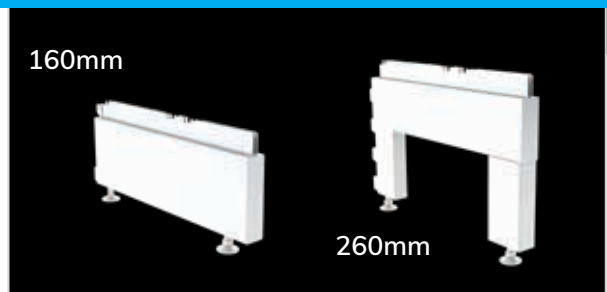

FRONT KICK PLATES

GD-C-FM (100) / GD-C-KP (200)

Colour	<input type="checkbox"/> White	
Lengths (mm)	600, 900, 1200	
Heights (mm)	100	200
Attaches To	160mm Base Feet	260mm Base Feet
Code (SKU)	GD-C-FM	GD-C-KP

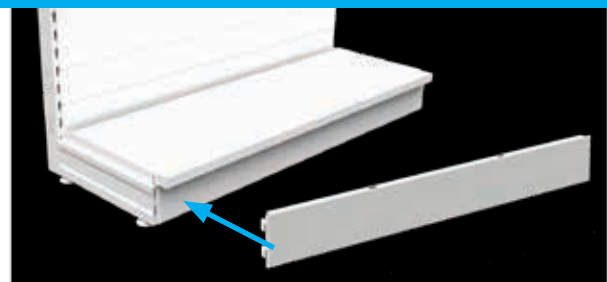

ROLL OUT BASE DRAWER

GD-C-USD

Colour	<input type="checkbox"/> White	
Length (mm)	Suits 1200 Wide Gondolas	
Heights (mm)	110	210
Sits Under	160mm Base Feet	260mm Base Feet
Depth (mm)	290 (Suits 300 D or Larger Base Shelf)	

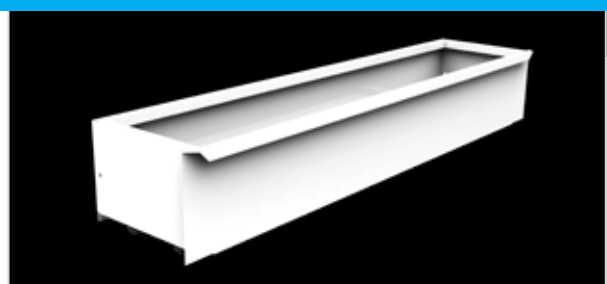

WALL STRIPPING

A simple method for effective shelving is the use of wall stripping. Choose your uprights, brackets and shelves for a streamlined display mounted to your wall. This method helps save on space and is much more cost effective than freestanding systems. Wall stripping is perfect for displaying lighter products on walls for a clean and uncluttered display.



WALL STRIP UPRIGHTS

Uprights consist of a 40mm pitch and are available with single or double slots. Single slots are suited for the end of your shelving whilst double slots are used for holding a bracket on either side for the continuation of shelving across a larger wall.

Chrome

Pack Qty	1	
Styles Available	Single Slot	Double Slot
Heights (mm)	1800, 2400	1800, 2400

WS-S & WS-D

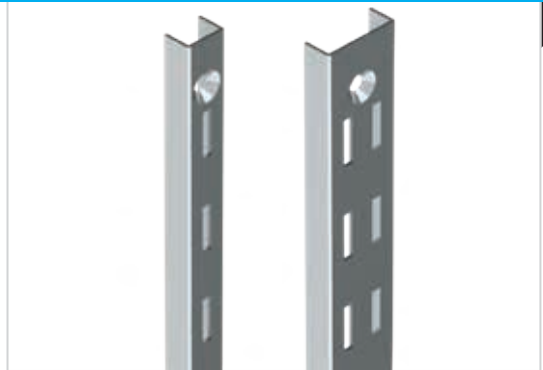

WALL STRIP SHELF BRACKETS

Brackets designed specifically for wall strips. Supports glass, acrylic or melamine shelves. Available in 200, 250, 300 and 400mm lengths. Use 2 brackets for each shelf length and connect multiple shelves for a larger area with the centre shelf grommets. Shelf grommets (sold separately on next page) protect shelves from scratches.

Chrome

Pack Qty	1
Lengths (mm)	200, 250, 300, 400

WS-BS

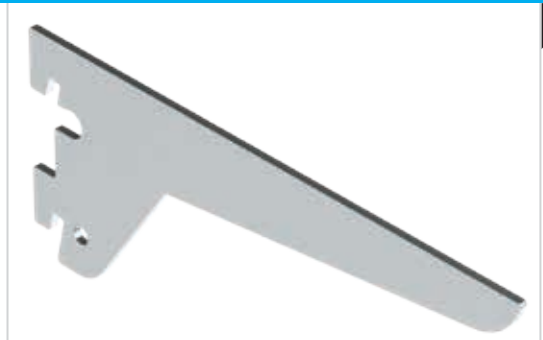

SHELF GROMMETS

Grommets are used on top of brackets before adding a shelf, to keep shelves sturdy and in their place. End grommets are used for the end of a shelf, whilst centre grommets are placed on top of a bracket to support shelving on either side.

Clear

Pack Qty	10
Styles Available	End or Centre

WSA-END / WSA-CEN



MDF SHELVES

A simple shelf for all applications. Consists of a laminated MDF board and 2mm PVC edging on all sides. Available in 3 lengths, all 18mm in total thickness. Use brackets and grommets (sold separately above) to add MDF shelves to your display.

White

Pack Qty	1
Lengths (mm)	600, 900, 1200
Depth of Shelf (mm)	300

SF-MEL

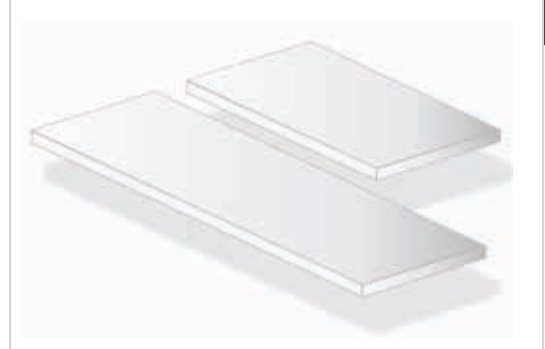

WALL STRIP HANGRAIL

Hangrails are used to hang garments outwards from a wall strip display. Insert shelves slightly smaller than the hangrail to utilise the open area at the front of the rail to hang merchandise. This allows you to both hang and shelve items on the one fitting. Choose a shelf 255mm deep (not included) to utilise this functionality. Brackets for holding shelves neatly within the hangrail are sold separately on page 60. A variety of hangrail lengths are available, all with 300mm depths.

Chrome

Pack Qty	1
Lengths (mm)	600, 900, 1200
Depth of Shelf (mm)	300
Size of Bar (mm)	12 W x 32 H

WS-HR12

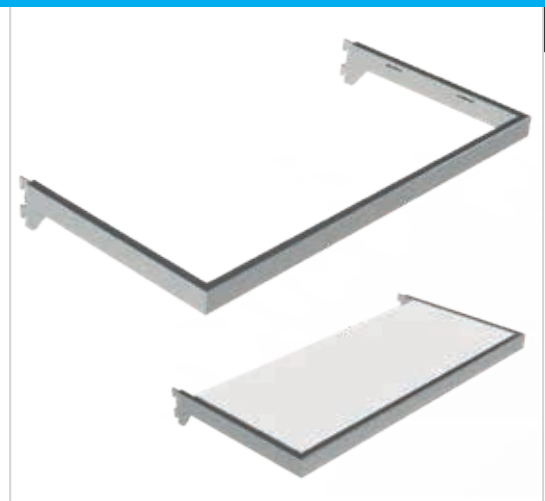

WALL STRIP CROSSBAR

Crossbars are connected either end to uprights. They allow for crossbar arms and hooks to be added to the wall strip system. Add crossbar hooks (sold separately SKU: DHB) to display hangsell merchandise or add crossbar arms (also sold separately) to display items out from the crossbar. See page 38 for crossbar hooks and arms.

Chrome

Pack Qty	1
Suits Bay Lengths (mm)	600, 900, 1200
Size of Bar (mm)	12 W x 32 H

WS-R12



EZI-GLIDE[®]

AUTO FACING ROLLER SHELVES



Front View



Side View

KEY FEATURES

- Quick and easy to install.
- Low maintenance resulting in reduced labour costs.
- Improves product presentation and ensures products are always front facing.
- Improved stock rotation, perfect for back fed refrigerated merchandising.
- Durable and long lasting.
- Versatile and adjustable dividers to support heavier products. Choose from steel wire or full steel dividers.
- Boosts category sales by offering a consistent display of stock.
- Mats can be modified to increase or decrease widths in 50mm increments.
- Other sizes can be ordered (minimum order quantities and lead times apply).

GRAVITY ROLLER SHELF MATS

EZ-G1-RS

The newest product gaining popularity is Ezi-Glide[®] roller shelves. This unique system is used as a gravity feed shelving solution which improves visibility of product and allows for easy re-merchandising. With it's auto facing ability, the result is no more empty facings, which equates to more sales!

Mat Colours	Black	Off White
Depths (mm)	572	294
Set Widths (mm)	693, 743	450
Width Sizing (mm)	Mat widths can be resized in 50mm increments	



PRODUCT DIVIDERS

Dividers are easy to move and align along numbered perforated front and back rails, creating perfectly straight displays. Choose from simple steel wire dividers for most everyday products or try the full steel style of dividers which stand 110mm in height, perfect for large and heavy items.

Chrome Stainless Steel Wire Full Steel Powder coated Black

Pack Qty	10		
Colour	Chrome	Black	
Styles Available	Stainless Steel Wire	Full Steel Metal	
Lengths (mm)	294	572	571
Heights (mm)	40	50, 70, 110, 120	110

EZ-G3-WD & EZ-G4-MD

110mm High Full Steel Powder Coated Black
EZ-G4-MD



3mm Stainless Steel Wire Dividers
EZ-G3-WD

FRONT RISERS

Place an acrylic riser at the front of the mat to stop products falling forward and off the shelf. The benefits of using clear front risers fed into the roller track from the sides means that the riser will not fall out and break unlike similar gravity fed systems used in the market which utilise a drop-in style of front riser.

Clear

Pack Qty	10		
Lengths (mm)	450	693	743
Heights (mm)	35	70, 100	50, 70, 100, 120

EZ-G2-FR



ANGLED SHELF SUPPORTS

If your shelf is unable to be angled itself, simply use our angled shelf supports to instantly angle the roller gravity mat. These angled shelf supports are so easy to use, just clip one onto either side of the back of the mat to sit your mat at either a 15 or 21 degree angle. Your products will now use gravity to slide along the rollers to the front of the mat creating the perfect self-facing system.

Silver Stainless Steel

Pack Qty	1
Angles	From the base of the shelf to the mat: 15°, 21°

EZ-G5-AS

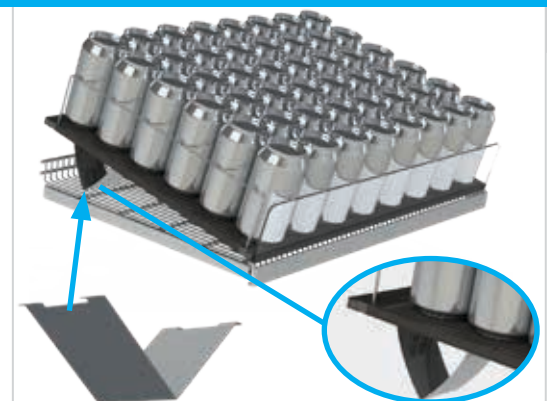

DIVIDE-IT[®]

SHELF MANAGEMENT SYSTEM

SI Retail's shelf dividers are designed for the ever changing in-store environment to allow for quick merchandising and a seamless product presentation. Pushers and Dividers are great tools for helping to reduce staffing costs related to shelf maintenance and enhance your customers shopping experience by making it even more convenient to browse.

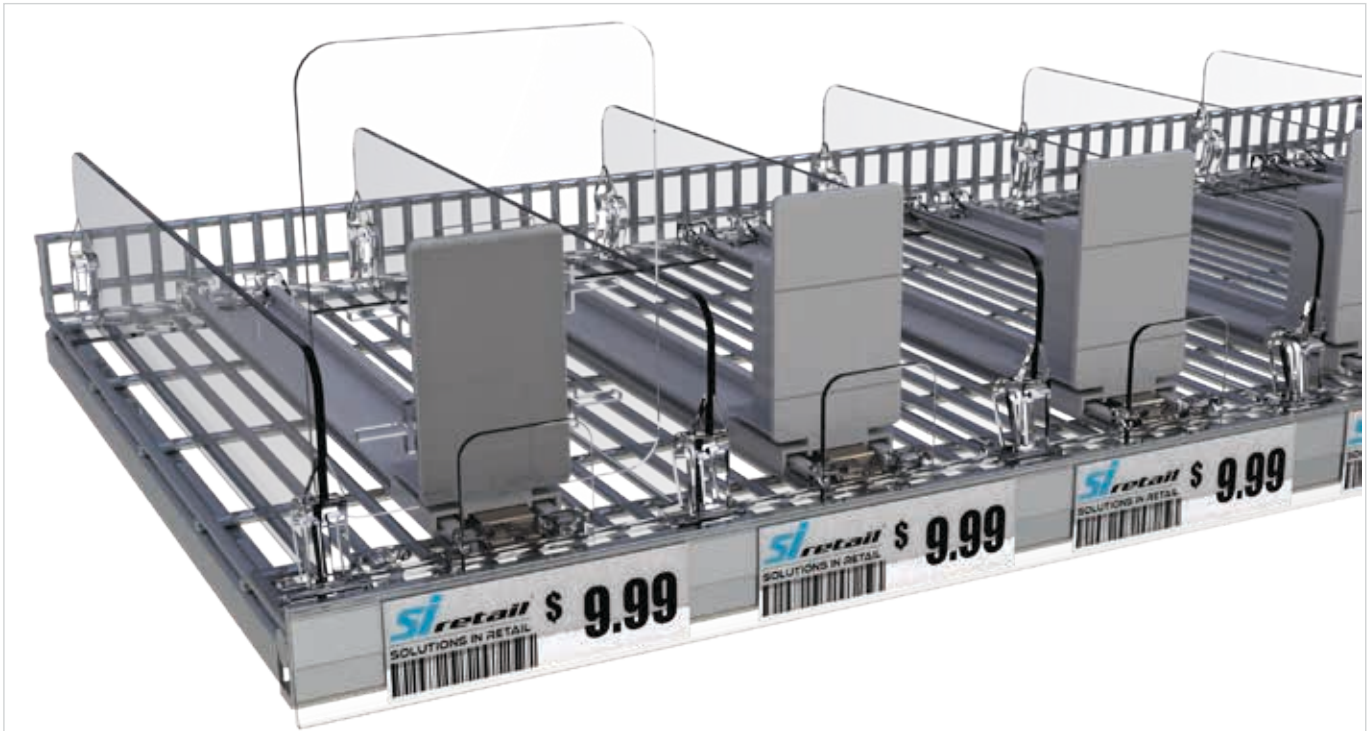

T-RAILS & RISERS

T-Rails sit on the front and back of shelves for the dividers and pushers to clip onto. They hold the dividers in place and are available in a clip-on version for wire shelves (extra replacement clips are also available), adhesive version for most applications or a magnetic version for metal shelves. Adhesive T-Rails with 40mm high front risers are commonly used with pushers to stop product from being pushed too far forward and off the shelf.

Clear

Pack Qty	10
Lengths (mm)	900, 914, 1200
Styles Available	Clip-On, Adhesive, Magnetic or Adhesive with 40mm High Front Riser

SMS-RT & SMS-RL

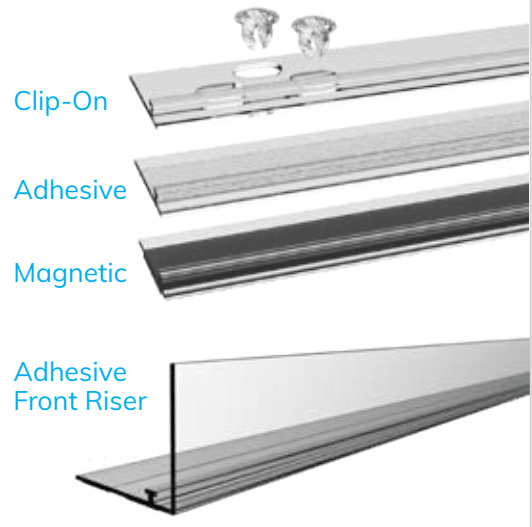

DIVIDERS

Dividers are used to separate different products on your shelves for a neat and consistent display. They are available in either a 60mm height or 120mm height and are made to a number of different lengths to suit all shelving sizes. T-Rails are sold separately and are placed along the front and back of the shelf for the dividers to clip into.

Clear

Pack Qty	40
Divider Heights (mm)	60, 120
60mm Divider Lengths (mm)	185, 260, 285, 335, 385, 435, 485
120mm Divider Lengths (mm)	335, 385, 435, 485

SMS-DS



PUSHERS

Pushers, Pusher Back Plates & Front Risers are commonly used with shelf dividers as a full shelf management system. The 30mm wide pusher connects to the T-Rail (between two shelf dividers) to ensure your products are always placed at the front of the shelf even when a customer takes an item. Pusher back plates can be added for larger items which need a taller pusher.

Combination of Grey & Clear

Pack Qty	10
Pusher Lengths (mm)	285, 335, 385, 435, 485
Pusher Back Plate (mm)	90 W x 115 H

SMS-P & SMS-PBS



EZI-LED™

SHELF LIGHTING



KEY FEATURES

- Choose from a **vertically stacked** shelf light kit or **horizontal daisy-chain** kit depending on your store layout and lighting preferences.
- Complete **plug & play solution**. Can be installed quickly and easily without any electricians.
- High intensity **cool white light (6500K)** allows your products to stand out.
- Life span of **up to 30,000 hours**.
- Energy efficient, **environmentally friendly** and reduces maintenance/operational costs.
- **Magnetic components** for a simple application onto any metal shelf or gondola.
- Choose from **white or black** components/hardware.

LAYOUT & ACCESSORIES

DAISY CHAIN

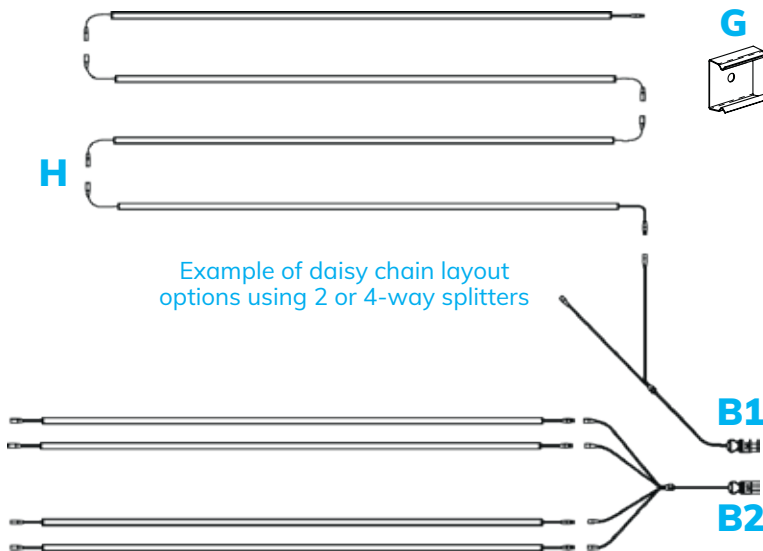

STACKED

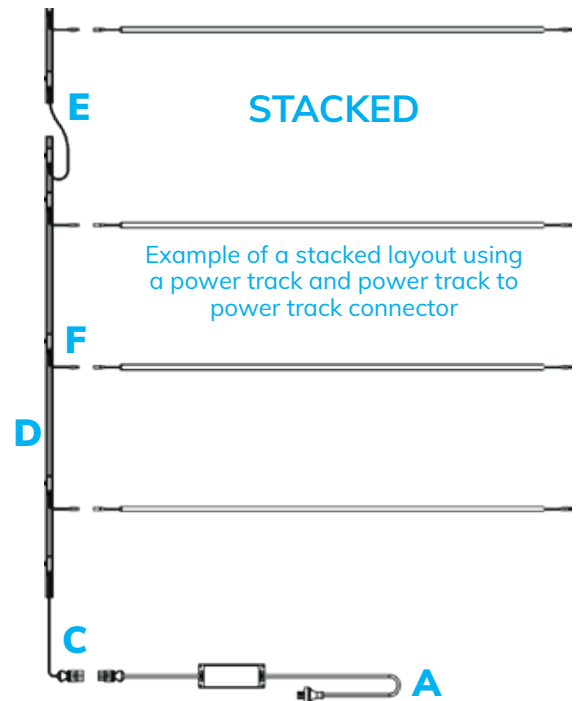

Item		Code (SKU)		Use	Sizes (mm)
A	Power Supply Transformer	75 W	LED-TF-MW24-75W	The main power supply for all lights. See max LED's per power supply on page across.	One Size
		100 W	LED-TF-MW24-100W		
		150 W	LED-TF-MW24-150W		
		200 W	LED-TF-MW24-200W		
B1	Power Supply Direct to LED Splitter	2-Way	LED-PC-MWST-2SPL	For use when daisy-chaining to link the power supply directly to the LED. Also used for splitting power to multiple rows when daisy chaining.	400 long (Black)
B2		4-Way	LED-PC-MWST-4SPL		
C	Power Supply to Power Track Connector	LED-PC-MWTF		For use when stacking kits. Connects the power supply to the power track.	1000
D	Magnetic Power Track	LED-PT		Attaches onto rear of the gondola to supply power.	600, 1200, 1800
E	Power Track to Power Track Connector	LED-PC-TT		To extend the power track on higher gondolas.	200
F	Power Track to LED Connector	LED-PC-TL		Gives power from the power track to the LED light.	500
G	Mounting U-Clip	LED-FL-UCLIP		For mounting LED's to a non-magnetic flat surface.	One Size
H	LED to LED Extension	LED-PC-LL		Links two LED's together for use when daisy chaining.	1000

SPECIFICATIONS

White
 Black

Full installation instructions available at siretail.com/files/led_instructions.pdf

LED Lengths (mm)	550	850	1150	
Suits Shelf Lengths (mm)	600	914	1200	
Wattage	6	9	12	
Max LED's Per Power Supply	75W	12	8	6
	100W	16	11	8
	150W	25	16	14
	200W	32	22	16
Suits Gondola Heights (mm)	1200-1800 & 1900-2400			
Voltage	24V			

STACKED LED KITS

Purchase an easy to assemble vertical kit and then add extra LED strip lights to light up all of your shelves! Kits are available depending on shelf configuration (1 x LED strip per shelf) and come complete with magnets to secure the LED strip and power track to your shelf.

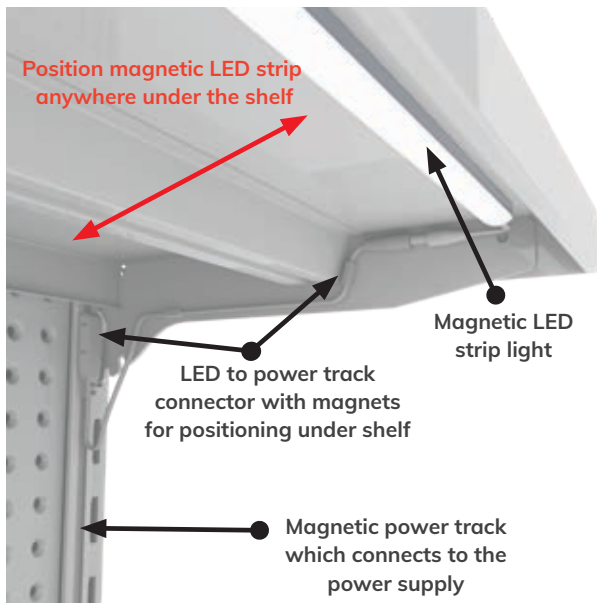

Position tracking rail with connectors along the rear (1) or side (2) of your gondola!



DAISY CHAIN LED KITS

Daisy chain LED kits are used for lighting a horizontal strip along gondolas whereby the power track is bypassed and instead, a direct link to the power supply is utilised (LED-PC-MWST). No power tracks or power track to LED connectors are required for a daisy-chain horizontal set up. LEDs connect to each other with an LED to LED connector (LED-PC-LL), creating a 'chain' of LED light across your store. Please note that no more than 4 lights are recommended per daisy chain splitter.

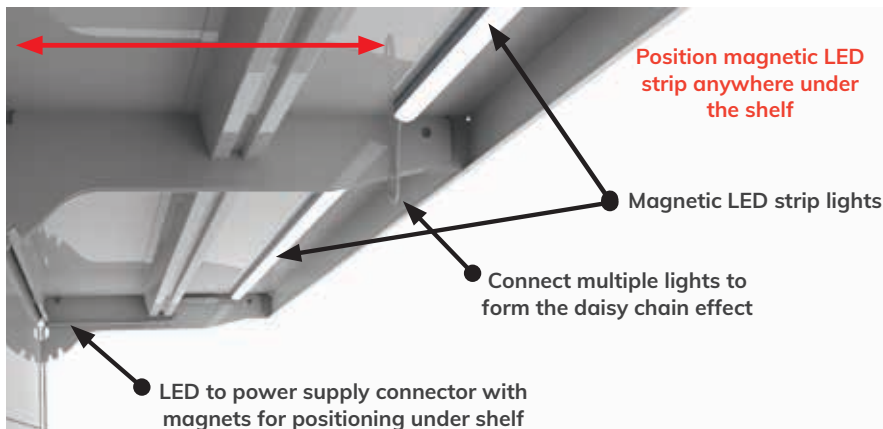

DATA STRIPPING

SI Retail offers the highest quality data strips. We stock a wide variety of profiles, sizes and styles including self-adhesive, hanging and clip-on versions, with a selection of colours, heights and lengths available.

The clear front panels protect your labels and are completely transparent to allow for accurate scanning of barcodes and maximum visibility to customers. All data strips can be cut to suit your shelves.

Efficient manufacturing techniques, high quality materials and superior Avery Dennison tape ensures our data strips are made to last and always present well.

The popular Avery Dennison tape boasts features such as:

- Resistance to heat, UV and humidity
- Stain resistance and elimination of yellowing or other colour changes
- Clear adhesive means an invisible assembly every time!

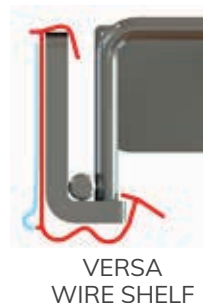

The first of its kind, patented clip-on feature - exclusive to SI Retail.

Granted Innovation Patent Nos. 2019100606 and 2019100660, Standard Patent Pending Nos. 2018204559 and 2019204920; Design Regn Nos. 201814049 and 201814050.

Introducing new Clip-On data strips. An alternative to traditional self-adhesive data strips; this style was designed with versatility in mind. In addition to being used on Versa flat metal shelves and EZI-Q® shelf options, it also clips onto most common standard wire shelves with a 27mm front face and 12mm return.

- No adhesive = less mess, less cleaning, an easier application and reduced labour costs.
- Temperature and humidity doesn't impact the stability. Ideal for use in cold rooms or refrigerators.
- Fits most common standard wire shelves. One data strip can be used in both the flat or angled position on Versa flat metal shelves with a simple clip-into-place motion.
- Available with or without the exclusive talker grip.

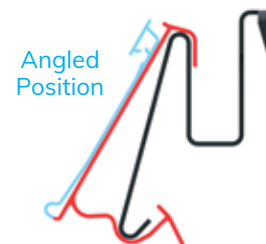
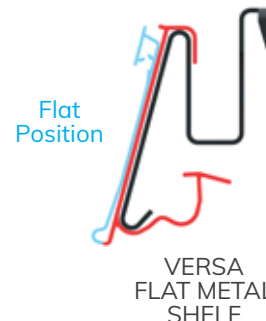

EXCLUSIVE TALKER GRIP

Our patent pending talker grip profile is the best design on the market today. The handy finger grip ridge allows for talkers or tickets to be easily inserted and removed, whilst the special flexible grip teeth ensure they don't fall out or rip when being pulled out.

Granted Innovation Patent Nos. 2019100606 and 2019100660, Standard Patent Pending Nos. 2018204559 and 2019204920; Design Regn Nos. 201814049 and 201814050.



CLIP-ON DATA STRIPS

DS-Q

This unique data strip design requires no tape at all. It simply clips onto the shelf edge and grips underneath the shelf lip for a secure, simple and clean application. The data strip can be adjusted to sit flat or angled on Versa flat metal shelves, and is designed to fit any wire shelf with a 27mm front face and 12mm return.

Black
 Grey

Pack Qty	50
Height (mm)	26
Lengths (mm)	902, 914, 1187

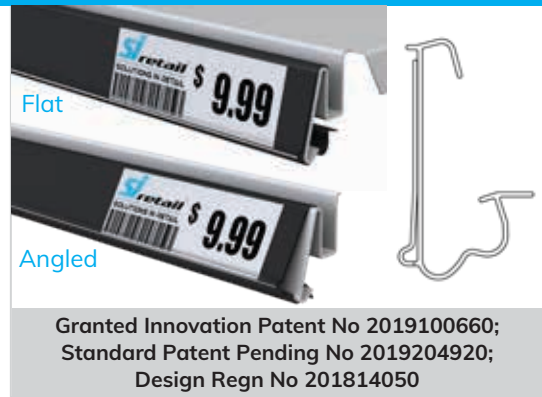

CLIP-ON DATA STRIPS WITH TALKER GRIP

DS-QTG

The revolutionary new data strip design which clips into place so easily without any tape or residue. This version includes the exclusive talker grip, making this a truly all-in-one data strip to suit wire shelves with a 27mm front face and 12mm return or SI Retails Versa shelves. Clip-On data strips are ideal for use in cool rooms or refrigerators.

Black
 Grey

Pack Qty	50
Height (mm)	26
Lengths (mm)	902, 914, 1187



FLAT DATA STRIPS

DS-S

Flat data strip is the most economical and easiest way to price your products on shelves. These data strips contain Avery adhesive tape which attaches to the front edge of your shelving for a neat presentation.

Clear
 Red
 Blue
 Black
 Grey

Pack Qty	50
Heights (mm)	26, 30 (Clear), 39 (Clear)
Lengths (mm)	914, 1200



FLAT DATA STRIPS WITH TALKER GRIP

DS-STG

SI Retail's flat data strip with talker grip is perfect for promoting specials or clearances. This design eliminates the need for any clips which can be messy when moved out of place. Avery adhesive tape is included for an easy application onto your shelves.

Clear
 Black
 Grey

Pack Qty	50
Height (mm)	26
Lengths (mm)	914, 1200



ANGLED DATA STRIPS

DS-V

Angled data strip is an economical and easy way to price your products on lower shelves. They are angled up at 35 degrees for easy readability and contain Avery adhesive tape which attaches to the front lip of your shelving for a neat presentation.

Pack Qty	50		
Colours	<input checked="" type="checkbox"/> Red	<input type="checkbox"/> Clear	<input type="checkbox"/> Black
Height (mm)	26		
Lengths (mm)	1200	914, 1200	1200



ANGLED DATA STRIPS WITH TALKER GRIP

DS-VTG

Angled data strip is also available with SI Retail's exclusive talker grip profile. It is perfect for lower shelves, as it allows for easy readability with the labels slightly angled up (35 degrees). This style includes Avery adhesive for a fast application onto your shelves.

Clear Black Grey

Pack Qty	50		
Height (mm)	26		
Lengths (mm)	914, 1200		



Granted Innovation Patent No 2019100606;
Standard Patent Pending No 2018204559;
Design Regn No 201713781

TOP TAPE ANGLED DATA STRIPS

DS-H

Top tape data strips are perfect for glass shelving and are slightly angled for greater visibility. They contain Avery adhesive tape which attaches onto the top of a shelf for a seamless presentation.

Pack Qty	50		
Colours	<input type="checkbox"/> White	<input type="checkbox"/> Clear	
Heights (mm)	30	26	30
Lengths (mm)	900	914, 1200	900, 914, 1200



HANGING DATA STRIPS

DS-C

Hanging data strips are designed to display labels on baskets and wire shelving. These come complete with clips to hook onto the shelf. Extra clips are available to be purchased separately if required (DSA-CLIP). Since no adhesive is used, hanging data strips are perfect for use in refrigerators or cold rooms to price items on shelves.

Pack Qty	50		
Colours	<input checked="" type="checkbox"/> Black	<input type="checkbox"/> Clear	
Heights (mm)	26	26	39
Lengths (mm)	105, 914	105, 914 1200	105, 1200



BULLNOSE DATA STRIP

Bullnose data strips are designed to display branding or to create separate categories within your store. It sits on top of shelves for instant visibility. This style includes an inbuilt T-rail for adding dividers and Avery adhesive foam tape for an easy application onto your shelves. This data strip includes a channel to insert an LED strip for lighting up the bullnose from the inside to make branding stand out and attract attention.

Clear

Pack Qty	25
Height (mm)	30
Lengths (mm)	914, 1200

DS-BN



JAW DATA STRIPS

A non-adhesive, push on style of data strip for melamine or glass shelves that leaves no sticky mess. The hinged feature on the 105mm length allows the price label to be flipped up to view old pricing information or product details. It's also handy when removing large items from a lower shelf as product won't get stuck against the data strip, instead it will flip up and out of the way as the product is pulled forward.

Clear

Pack Qty	10	
For Shelf Thickness (mm)	5-10	20
Fits Label Height (mm)	26	30
Lengths (mm)	1040, 1130	105

DSA-JAW



CURVE-IT DATA STRIPS

This style of data strip is perfect for use in cool rooms or refrigerators since it doesn't contain any adhesive. It sits over the top lip of the shelf and provides a clear scan strip for labeling purposes. Add stabiliser clips (page 30) to attach tickets or talkers.

Clear Black

Pack Qty	25
Height (mm)	26
Length (mm)	738

DS-CI



DATA STRIP ACCESSORIES

Shelf merchandising is an important aspect for maintaining a well-organised store environment. Help customers identify pricing and product information through a display system which promotes professionalism.

Whatever your needs are, SI Retail stocks a variety of durable data strip accessories. There is a wide range of sizes and different configurations to suit your brand and display preferences.



Ticket Stabiliser Clips shown (DSA-C25)



Perpendicular Ticket Grip shown (DSA-GH30)



PVC Ticket Pockets shown (DSA-PVC-A7)

DATA STRIP OPENER

A handy tool which makes opening data strip and placing labels much easier. Use the tip to separate the clear front face from the coloured backing when inserting labels.

■ Black

Pack Qty	1
Size (mm)	128 L x 17 D x 20 W

DSA-OPENER



SHELF TALKER/TICKET STABILISER

DSA-C25

An economical and simple shelf talker/ticket stabiliser clip which fits into the front window of flat data strip for adding promotional tickets/talkers. It holds tickets against the shelf and can be used as a substitute for talker grip data strip.

Clear

Pack Qty	100
Size (mm)	25 L x 15 H



SHELF TALKER/TICKET GRIPS

DSA-G

Data strip grips help to display promotional tickets/talkers in different ways along an aisle. Hinged (A) grips allow signage to flex when bumped meaning signage doesn't fall out of the grip when taking products off the shelf. Basket (B) grips are perfect for hanging signs from wire whilst fixed (C) grips hold talkers against the data strip. The perpendicular (D) grip holds the ticket out from the shelf for high impact.

Clear

Pack Qty	25			
Styles Available	A Hinged	B Basket	C Fixed	D Perpendicular

A DSA-GV25



B DSA-GB25

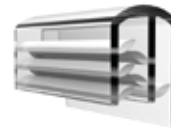

C DSA-GF25

D DSA-GH30

ADHESIVE SPRING WOBBLER

DSA-AWOB

Peel off the two square sticky backings then add your ticket/talker to one end and attach the other end to a flat surface. This enables the promotional ticket to wobble in order to attract more attention to your product and the promotion.

White With Silver Spring

Pack Qty	10
Size (mm)	Adhesive Square: 20 W x 20 L Spring: 33 L



PVC PLASTIC TALKER/TICKET POCKET

DSA-PVC-A7

The clear protective PVC helps keep promotional talkers/tickets from ripping. Simply place your promotional ticket into the pocket then insert the top flap into any standard flat data strip. Great solution to protect tickets from becoming wet whilst in refrigerated conditions.

Clear

Pack Qty	10
Artwork Insert Size (mm)	A7 Talkers/Tickets (74 W x 105 H)



DISPLAY HOOKS

Hangsell products are best displayed on hooks! Whether you have a Volcano Board, Pegboard, Slatwall, Flat Metal or Grid Mesh Panel, SI Retail has the hooks to suit.

SI Retail's flip scan display hooks are designed so that the label remains level irrespective of the load on the hook, meaning all of your labels will align neatly no matter what you are displaying. With a large array of sizes and wire diameters, there are hooks to suit every application.

VOLCANO PEGBOARD

LOOP HOOK

DHP-L4

Gain stability when displaying heavy products with the use of loop hooks. They suit Volcano Board, Pegboard and Slatwall and are available in a wide variety of lengths.

Chrome

Pack Qty	25
Lengths (mm)	75, 100, 150, 225
Wire Diameter (mm)	4

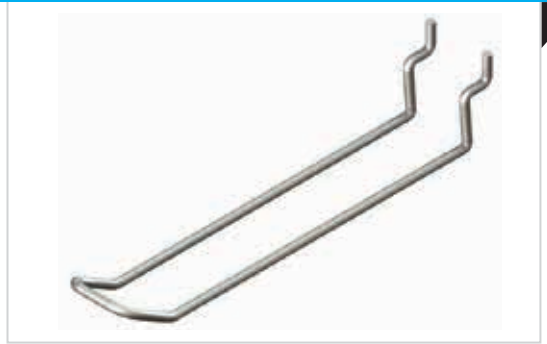

FLIP SCAN LOOP HOOK

DHP-FL4

Chrome flip scan loop hooks provide an area to attach a label holder (sold separately). They suit Volcano Board, Pegboard and Slatwall and are available in a variety of different lengths. They help to hang unbalanced packaging evenly. Label holders are available in many different colours and with or without a talker grip.

Chrome

Pack Qty	25
Lengths (mm)	150, 225
Wire Diameter (mm)	4



SINGLE PRONG

DHP-S

Pegboard single prong hooks suit Volcano Board and Slatwall too. They are available in a wide variety of lengths and wire diameters. These simple hooks keep your hangsell products looking neat and tidy.

Chrome

Pack Qty	25	
Lengths (mm)	50, 75, 100	150, 225, 300
Wire Diameters (mm)	4	5



FLIP SCAN

Chrome flip scan hooks provide an area to attach a label holder (sold separately) and suit Volcano Board, Pegboard and Slatwall panels. Choose from a variety of lengths and two different wire diameters. Label holders are available in many different colours, sizes and with or without a talker grip.

Chrome

Pack Qty	25	
Lengths (mm)	75, 100, 150	150, 225, 300, 400
Wire Diameters (mm)	5	6



Label holder
sold separately
(page 39)

SINGLE PRONG FASTBACK

Perfect for tight spaces such as under shelves, fastback display hook stems attach to a fastback adapter. This combination is designed to save time by helping you place or move hooks on display without removing shelves or merchandise around the hook as there is no need to tilt the hook up to insert it into your gondola panel.

Chrome

Pack Qty	25	
Lengths (mm)	150, 225, 300	
Wire Diameter (mm)	5.5	

Stem and fastback
can be ordered
separately



FLIP SCAN FASTBACK

Flip scan fastback hooks provide an area to attach a label holder (sold separately). Hook stems are universally designed to clip into different adapters as required, meaning one hook stem will fit both adapters (Pegboard or Grid Mesh). The fastback style allows for a direct application into tight spaces such as under shelves or in-between merchandise as the stem does not require tilting upwards to be inserted.

Chrome

Pack Qty	25	
Lengths (mm)	150, 225, 300	
Wire Diameter (mm)	5.5	

Stem and fastback
can be ordered
separately



Label holder
sold separately
(page 39)

REPLACEMENT PEG FASTBACK ADAPTER

The Pegboard fastback adapter is made from durable ABS plastic and fit onto Pegboard/Volcano Board backing panels. Simply attach onto your Pegboard/Volcano Board gondola and connect a single prong or flip scan fastback hook.

Grey Adapter

Pack Qty	25	
Size (mm)	45 W x 65 H x 30 D	

DHA-FB-PEG



FLAT METALBOARD

SINGLE PRONG

These single prong hooks are designed specifically for flat Metalboard applications. Select from a variety of lengths to suit your merchandise.

Chrome

Pack Qty	25
Lengths (mm)	100, 150, 225
Wire Diameter (mm)	5

DHM-D



FLIP SCAN

Metalboard flip scan hooks are designed specifically for perforated flat metal panels. They include an area to attach a label holder (sold separately). Label holders are available in many different colours, sizes and with or without a talker grip.

Chrome

Pack Qty	25	
Lengths (mm)	100, 150, 225	150, 225, 300
Wire Diameter (mm)	5	6

DHM-F



Label holder
sold separately
(page 39)

PEGBOARD TO METALBOARD ADAPTER

A simple adapter which enables a Pegboard hook (see previous page) to fit into a flat perforated Metalboard panel. The adapter attaches to the back of any Pegboard/Volcano board hook to retain the same angle as other Metalboard hooks.

Light Grey Black

Pack Qty	25
Size (mm)	37 W x 35 H x 3 D

DHA-MA



SLATWALL

SINGLE PRONG - PLATE STYLE

DHS-S

These single prong hooks are designed specifically for Slatwall applications. Select from a variety of lengths to suit your merchandise.

Chrome

Pack Qty	25
Lengths (mm)	50, 100, 150, 200, 300
Wire Diameter (mm)	6



FLIP SCAN - PLATE STYLE

DHS-F

These flip scan hooks are designed specifically for Slatwall. They are available in a wide variety of lengths and designed with an area to attach a label holder (sold separately). Label holders are available in many different colours and with or without a talker grip.

Chrome

Pack Qty	25
Lengths (mm)	100, 150, 200
Wire Diameters (mm)	6

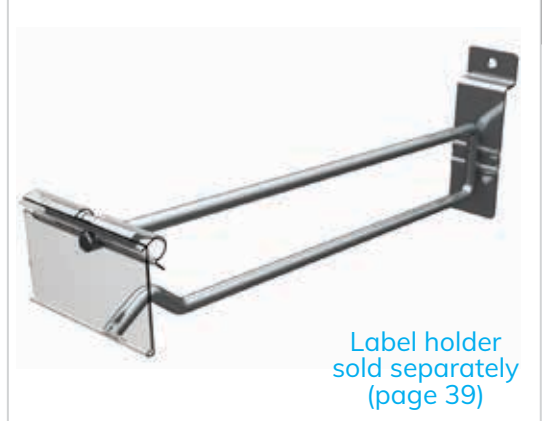

LOOP HOOK - PLATE STYLE

DHS-L6

These loop hooks are designed specifically for Slatwall. Loop hooks help to hang unbalanced packaging evenly, while the large back plate aids in supporting heavier products.

Chrome

Pack Qty	25
Lengths (mm)	100, 150, 200
Wire Diameter (mm)	6

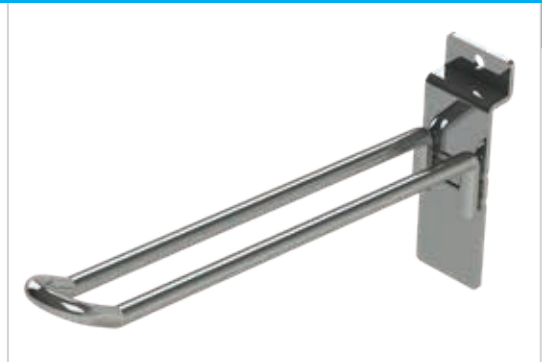

GRID MESH

SINGLE PRONG

DHG50-S

Single prong Grid Mesh hooks are designed to fit 25-50mm mesh. Select from multiple sizes to suit your merchandise and display requirements.

Chrome

Pack Qty	25	
Lengths (mm)	150	225, 300
Wire Diameters (mm)	5	6



FLIP SCAN

DHG50-F

The new version of flip scan grid mesh hooks provide an area to attach a label holder (sold separately) and suit 25-50mm Grid Mesh. This new design makes it harder for hooks to get knocked off mesh panels. A variety of lengths are available for both black or chrome colours.

Chrome Black

Pack Qty	25	
Lengths (mm)	100, 150	225, 300
Wire Diameters (mm)	5	6

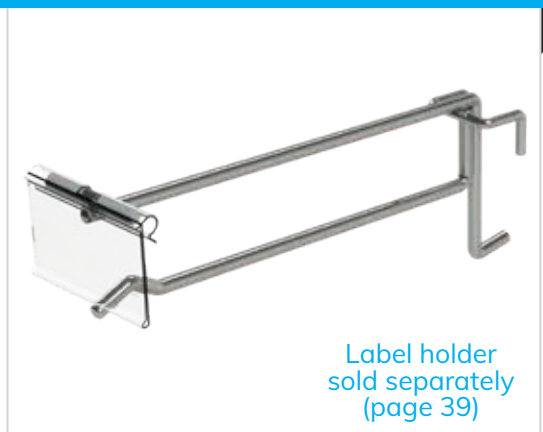

SINGLE PRONG FASTBACK

Perfect for tight spaces such as under shelves, fastback display hook stems attach to a fastback adapter to fit grid mesh panels with a 25 or 50mm pitch. This combination is designed to save time by helping you place or move hooks on display without removing surrounding shelves, hooks or other merchandise. One fastback hook stem fits all fastback adapters.

Chrome

Pack Qty	25
Lengths (mm)	150, 225, 300
Wire Diameter (mm)	5.5

DHGF-S-T

Stem and fastback can be ordered separately



FLIP SCAN FASTBACK

Chrome flip scan fastback hooks provide an area to attach a label holder (sold separately). These hooks are universally designed to clip into different adapters as required. Adapters are available to suit Pegboard/Volcano Board or 25-50mm Grid Mesh panels. This hook and adapter combination suits Grid Mesh and allows for a direct application into tight spaces without having to be tilted upwards to be inserted.

Chrome

Pack Qty	25
Lengths (mm)	150, 225, 300
Wire Diameter (mm)	5.5

DHGF-F-T

Stem and fastback can be ordered separately

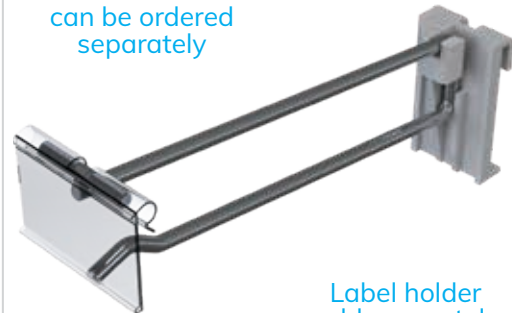

Label holder sold separately (page 39)

REPLACEMENT GRID FASTBACK ADAPTER

The Grid fastback adapter is made from durable ABS plastic and shaped to fit onto 25 or 50mm Grid Mesh backing panels. Simply attach onto your Grid Mesh gondola and connect a single prong or flip scan fastback hook.

Grey Adapter

Pack Qty	25
Size (mm)	35 W x 62 H x 25 D

DHA-FB-GRID



SPECIALTY HOOKS

HAMMER HOOK

Suits volcano pegboard, flat metal and slatwall panels. Holds approximately 3 hammers on an angle. Can be used for many different products in other industries that are sized approximately 130mm in length and under 200mm wide. The middle prong also acts as a label holder to ensure your products are easily priced. Labels are sold separately.

Chrome

Pack Qty	5
Length (mm)	250
Width (mm)	Protrudes 140mm from gondola

DHP-HH



SHOVEL HOOK

Perfect for hardware stores but can be used for many other applications. The shovel hook fits onto volcano pegboard, flat metal and slatwall panels. It holds 6 shovels front on and is made from high quality durable steel.

Black

Pack Qty	15
Length (mm)	155
Width (mm)	Protrudes 390mm from gondola

DHP-SH



HOOK SECURITY

STOP LOCKS

Secure merchandise on your hooks and prevent theft with SI Retail's stop lock range. Make sure to purchase a magnetic key to open the stop locks (available separately DHA-MAGKEY).

Red Black White (8mm Only)

Pack Qty	10		
Stop Lock Size (mm)	4	6	8
Colour of Stop Locks	Red	Red or Black	White
Suits Hook Diameters	Up to 4mm	Up to 6mm	Up to 8mm

DHA-STOP-LOK



CROSSBAR HOOKS & ARMS

SINGLE PRONG 12mm CROSSBAR HOOK

DHB-S6

Crossbar hooks attach to crossbars by simply placing the open gap section of the hook over the top of the crossbar and pressing down to lock it in place. They include a velvet inner to prevent scratches to the crossbar when attaching it.

Chrome

Pack Qty	25
Lengths (mm)	100, 150, 200
Suits	Any 12mm Crossbar (Versa / EZI-Q®)



FLIP SCAN 12mm CROSSBAR HOOK

DHB-F6

Simply attach this hook to a crossbar by placing the open gap section of the hook over the top of the crossbar and pressing down to lock it in place. A velvet inner prevents scratches to the crossbar. This style of hook includes an area for attaching a label holder (sold separately) to price items hanging from the hook.

Black Chrome

Pack Qty	25
Lengths (mm)	100, 150, 225
Suits	Any 12mm Crossbar (Versa / EZI-Q®)

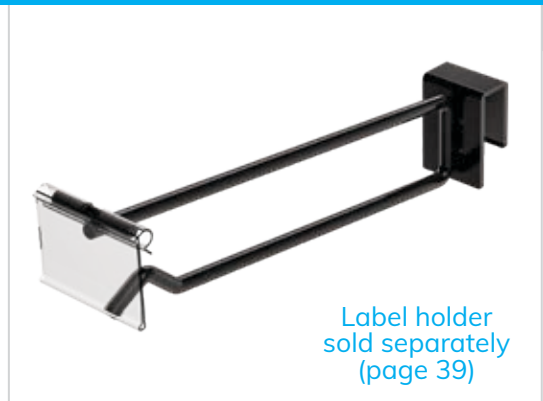

12mm CROSSBAR ARMS

WS-R12

Crossbar arms are used to display garments out from a 12mm crossbar in order to save space on your floor. They help to ensure a neat apparel display and include notches so hangers cannot slide off the front. Many different styles are available to suit a variety of different clothing items.

Chrome Arms

Pack Qty	1			
Style	A Straight	B Crank	C Waterfall	D Straight Round
Code/SKU	WS-R12R	WS-R12C370	WS-R12WFS9P	WS-R12L300
Size (mm)	300, 400	370 Length x 200 Drop / Step Down	400 L x 18 W	300 x 15.9 Diameter



DISPLAY HOOK ACCESSORIES

FLIP SCAN LABEL HOLDER

DS-F

Label holders attach to the flip scan hooks to present product information for items hanging on the hook. They can be moved out of the way by flipping it upwards when re-stocking products on the hook.

Pack Qty	25				
Colours	<input checked="" type="checkbox"/> Red	<input checked="" type="checkbox"/> Black	<input type="checkbox"/> Clear		
Heights (mm)	26			30	39
Lengths (mm)	50, 80	50, 55, 80	50, 55, 65, 70, 75, 80	50	80



FLIP SCAN LABEL HOLDER WITH TALKER GRIP

DS-FTG

The addition of a talker grip as part of the label holder allows for promotional talkers, pricing or other promotions to be added to the label.

Clear Black

Pack Qty	25
Height (mm)	26
Lengths (mm)	50, 80



Granted Innovation Patent No 2019100606;
Standard Patent Pending No 2018204559;
Design Regn No 201713782

HANG TABS

DHA-HT

Repair broken packaging with hang tabs or add them to merchandise without pre-punched holes. They affix to most materials for hanging product onto hooks. Sold in packs of 10, one pack contains 20-24 hang tabs (depending on style of hang tabs). Delta 50 x 50 contains 10 tabs/pack.

Clear

Styles	A Round	B Euro	C Delta	D Hook
Code (SKU): DHA-HT	32R22	40E35	35045 & 50B50	45025

A Round B Euro C Delta D Hook

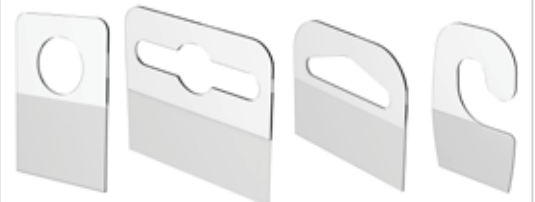

Sizes (mm)

22 x 32 40 x 35 45 x 35
50 x 50 25 x 45

INVENTORY CONTROL CLIPS

DHA-ICLIP

Inventory control clips are designed to keep your products at the front of your display hooks for a neat product presentation.

Opaque

Pack Qty	100
One Size Suits (mm)	3.8 to 6.5 Diameter Hooks



IMPULSE DISPLAYS

BULK GOODS MOBILE DISPLAY

FD-BG-CR

This custom display was designed to carry large and heavy loads. The strong centre pole helps you to easily guide the display around your store utilising the four heavy duty castors. This allows bulk items to be displayed in different impulse locations without the strain of continually lifting heavy products.

■ Charcoal Unit ■ Black Ticket Frame

Pack Qty	1
Size of Base (mm)	1000 L x 600 D
Height (mm)	1422
Weight Limit	250 KG
Box Contents	1 x Pole, 1 x A4 Ticket Frame, 1 x Mesh Base, 4 x Castor Wheels (2 Lockable)



DUMP BINS

BB-DBS

A great way to display your popular stock, clearance lines or promotional products. Includes a height adjustable shelf to fit products of various sizes. Available with or without the base which includes lockable castor wheels. The dump bins are foldable for easy transportation and storage. See page 45 for a range of dump bin signage options.

■ Black □ White

Pack Qty	1
Sizes With Base (mm)	460 x 460 x 820 H 620 x 620 x 970 H
Sizes Without Base (mm)	460 x 460 x 750 H 620 x 620 x 900 H

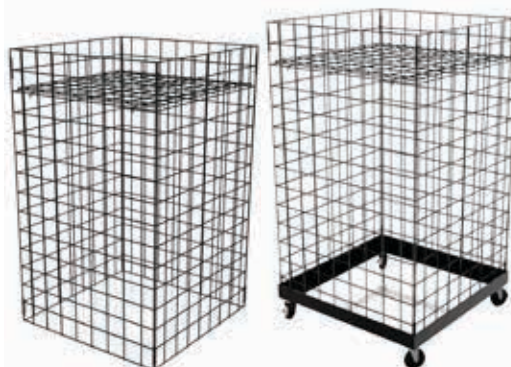

ADJUSTABLE PALLET GUARD

FD-PG-BK

A simple method for concealing the base of existing pallets to make it more attractive and help draw attention to products. Pallet guards also have the added safety benefit of ensuring the corners of pallets are fully covered, protecting customers from any sharp edges. All wooden edges are completely hidden, resulting in a visually appealing display. Add custom promotional messages to your pallet guard by inserting printed corflute (shown in image). Contact us for a template.

■ Black

Height of Unit (mm)	165 (corners), 150 (elastic sides)
Length of Elastic (mm)	Adjustable perimeter from 3600 to 5000
Box Contents	3 x Slide Through Corners, 1 x End Corner, 1 x Elastic Strap, 1 x Installation Instructions



Image shows printed corflutes inserted

HAND SANITISER STATION

An effective hand sanitiser stand to encourage personal hand hygiene for preventing the spread of viruses and bacteria in busy or high traffic locations. Ideal for use in waiting rooms, break rooms, restrooms, entryways, offices, retail stores and all other busy locations; the portable and durable hand sanitising station is a vital necessity in any area to maintain a high level of hygiene. Please contact us for a double-sided stand or if you require any customisations.



KEY FEATURES

- Strong and heavy-duty, metal components.
- Flexibility to hold different shaped sanitiser bottles.
- Versatility of swapping out ticket frames for other colours/sizes.
- The design allows for an extra cradle to be added (making the stand a double-sided station).
- Customisable options such as colour, lockable or different sized cradle holders are available upon request.

FREE STANDING SANITISER STATION

FD-SANKIT-1W-WT-T

Colour	<input type="checkbox"/> White
Materials	Plastic ticket frame; Metal post, base & wire cradle
Included Components	<ul style="list-style-type: none"> • Heavy-duty, round metal base • Sturdy metal post • Sanitiser cradle with ticket frame stem • A4 Ticket frame • A4 Clear PVC artwork protector • T-piece ticket frame connector • "Hand Sanitising Station" sign
Versatile Sanitiser Cradle	Size: 116mm W x 139mm D x 164.5mm H Holds 1 x 500ml capacity hand sanitiser pump dispenser/bottle (not included)
Height	1590mm
Post Diameter	45mm
Base Diameter	450mm

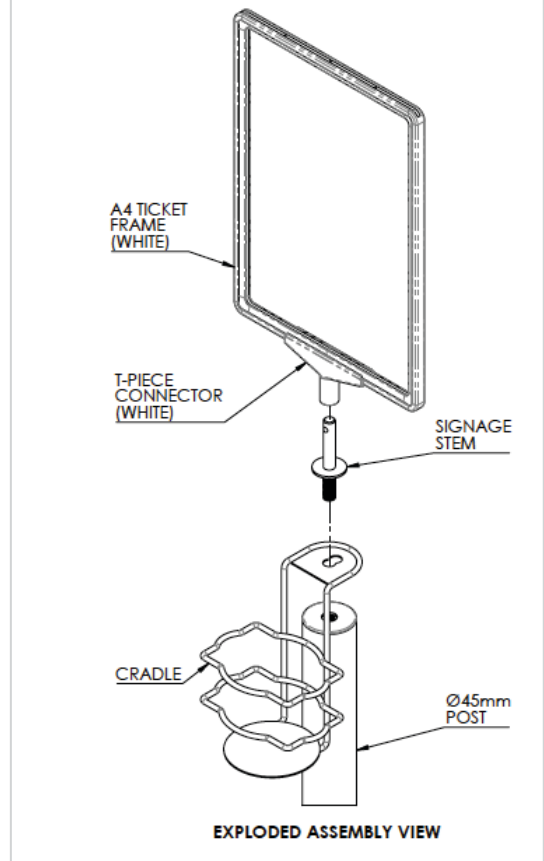

Front Views

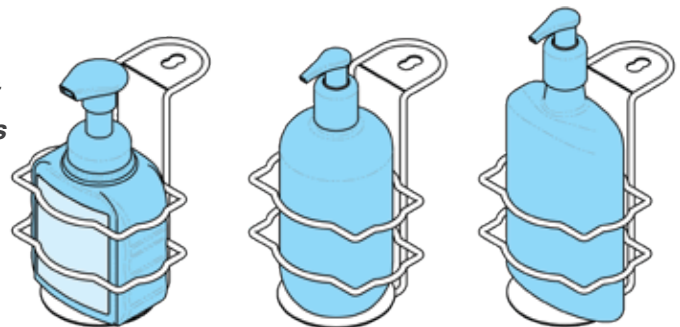

Aerial Views



EZI-Q® INTEGRATION

The wire cradle can also be used on the revenue generating EZI-Q® impulse display system.

See page 5 for more information.

SIGNAGE / POINT OF SALE

SI Retail provides a complete range of signage and point of sale display systems to suit all retail outlets. From external sign boards, window signage, internal snap frames, hanging banners and shopping baskets to talker ticketing, poster grips, and general visual merchandising signage; the possibilities are endless.

Signs are used to draw attention to promotions and to convey information about your business. Below are examples of how some stores are utilising signage to entice customers. The aisle sign below is held up using two magnetic aisle sign holders attached to the gondola. Quality is imperative when it comes to holding signage and SI Retail only stock the highest quality sign holders, acrylics, T-grips and ticket frames.



END-SIGNS

Created in 1974, the End-Sign was the foundation of our business and is still an effective promotional tool used on store fronts to increase product or brand awareness. Stand out to customers and maximise your exposure with an eye catching custom printed end-sign. Perfect for attaching to shop windows, the end-sign makes it easy for customers to find your store and is a cost effective tool for attracting passing traffic.



Featuring a high quality and solid design; the end-sign components can be purchased individually or as a full kit. UV stabilised blank flags withstand environmental elements and are available to be purchased for custom printing by your local print specialist.

1



Peel off the double-sided tape backing from the base and adhere to a surface.

2



Insert the bush into the top of the base and slide it down to lock it into place.

3

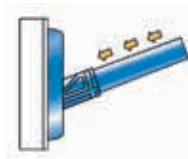

Insert the pole into the bush.

4

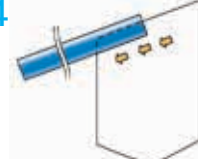

Insert the flag into the slit of the pole.

5



Attach the end cap to the pole to lock the flag into place.

END-SIGN KITS

This kit contains all components needed for an end-sign except for the flag. Available in black or white, the kit contains an adhesive base, a bush which slides into the base (allowing you to display your flag on two different angles with the option of mounting the base vertically or horizontally), the main pole and the end cap which is placed on the end of the pole once your flag is inserted to lock the flag in place.

Black White

Pack Qty	1			
Components Included	Base	Bush	Pole	Cap
Code (SKU)	ES-BASE	ES-BUSH	ES-POLE	ES-CAP
Size (mm)	47 W x 122 L	32 H x 58 L	790 L	25 L

ES-UNIT-T



*Flag not included in kits. Please see below for blank printable flags

END-SIGN FLAGS

Blank flags are available in two different styles/shapes. Choose between a V shaped or flat bottom. They are UV stabilised and made from blockout reinforced vinyl. Ready for printing by your local print specialist.

White

Pack Qty	1	
Shape/Style	V Bottom	Flat Bottom
Code (SKU)	ES-B-BLANK-V	ES-B-BLANK-F
Size (mm)	680 H x 420 W	

ES-BLANK

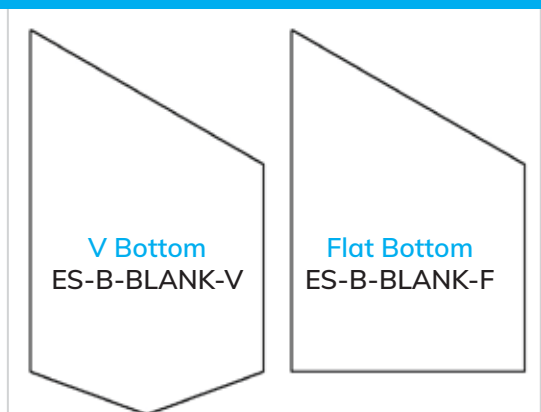

ACRYLIC SIGNAGE

DUMP BIN SIGN HOLDERS

Use clear sign holders to display information such as pricing or promotions on dump bins. Choose from a strong 3mm thick acrylic version (SH-DB-L) or a cost effective PVC version (SH-DB-PVC).

Clear

Pack Qty	1	
Style	Acrylic (SH-DB-L)	PVC (SH-DB-PVC)
Size	A4	
Orientations Available	Portrait, Landscape	Portrait

SH-DB-LA4 / SH-DB-PVC

Can be hung from any panel or fixture up to 6mm thick



DUMP BIN TICKET FRAME SIGN HOLDER

Use an adjustable sign holder to display information such as pricing or promotions at eye level on dump bins or other mesh displays. The telescopic pole allows for increasing the height up to another 200mm. Ticket frames are available separately in a variety of sizes.

Grey

Pack Qty	1
Adjustable Stem (mm)	365 to 570
Comprised Of	Aluminium pole, metal spring, grey plastic grips and clear ticket frame clamp

SH-DBG



Dump Bin and Ticket Frame sold separately

WALL MOUNT KITS

A very modern and easy to install acrylic signage system. Use two acrylics and four chrome standoffs to create a wall mounted sign (6 for larger sizes). Ideal for shops and offices, wall mount kits protect your artwork. Acrylics and wall mounts are also available separately.

Clear Acrylic Chrome Standoff

Pack Qty	1 (Two Sheets of Acrylic)			
Acrylic Sizes	A1	A2	A3	A4
No. Of Wall Mounts	6	6	4	4

WM-A



Chrome Standoff (19mm x 25mm) WM-19L25SI

BUSINESS CARD HOLDER

Our sleek and modern acrylic business card holder is the perfect addition to any workplace counter top or reception area.

Clear

Pack Qty	1
Size (mm)	110 L x 57 H x 46 D
Orientation	Holds cards in landscape position

CD-BCH



ACRYLIC SIGN HOLDERS

Ideal for counter and glass displays, acrylics are an economical way to display your promotions. Available in a variety of sizes and styles, the 2mm thick acrylic will not break easily and can be re-used for years. It also ensures your artwork is protected for a very long time.

Clear

Pack Qty	5	
Styles Available	Single Sided	Double Sided
Code (SKU)	SH-ASS	SH-ADS
Sizes	A4, A5, A6, A7	A3 (3mm Acrylic)
Orientations	Portrait	Landscape

SH-A

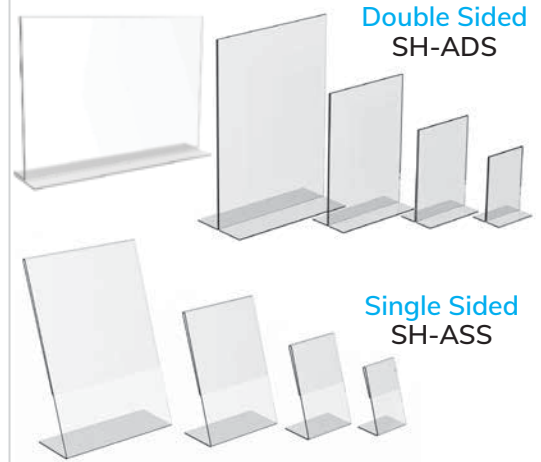

ANGLED ACRYLIC COUNTER STANDS

Versatile 4mm thick angled acrylic display ideal for displaying a variety of items such as books, plates, iPads, frames and more. Available in two sizes, small or large.

Clear

Pack Qty	1
Sizes (mm)	Small: 75 W x 140 L x 150 H Large: 100 W x 170 L x 230 H

SH-AAS

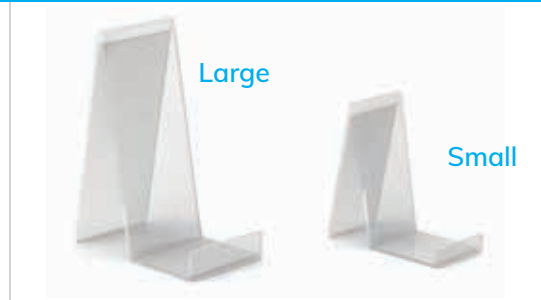

ACRYLIC RISER COUNTER DISPLAY SET

Set of 6 stylish acrylic risers, each smaller than the next. Perfect to feature or display small products at different levels on shelves, counters or table tops. Can be used separately. Made from 4mm thick acrylic.

Clear

Pack Qty	1
Size (mm)	Smallest: 120 L x 100 W Largest: 220 L x 100 W

CD-RISER6-4A

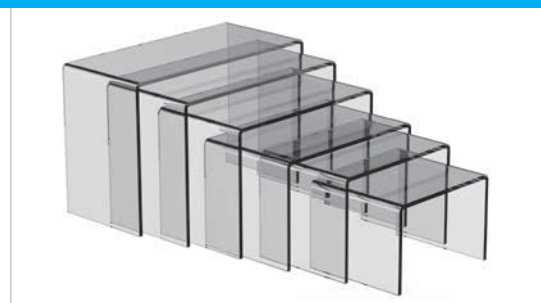

TICKET FRAME CLIP - LARGE

A large clear clip which holds ticket frames onto fixtures up to 10mm thick. The angle of the ticket frame can be adjusted to lean forwards or backwards out from the fixture.

Clear

Pack Qty	1
Size (mm)	45 W x 94 H x 26 D

TF-DBC



SIGN HOLDERS

TICKET FRAMES

Use ticket frames to display information such as pricing or promotions around the store. Available in three different sizes, ticket frames can be placed in a portrait or landscape position with various attachments such as feet, stems, bases and magnetic clips available.

Black
 Red
 Blue
 White (A4)
 Clear

Pack Qty	1
Sizes Available	A3, A4, A5

TF-A

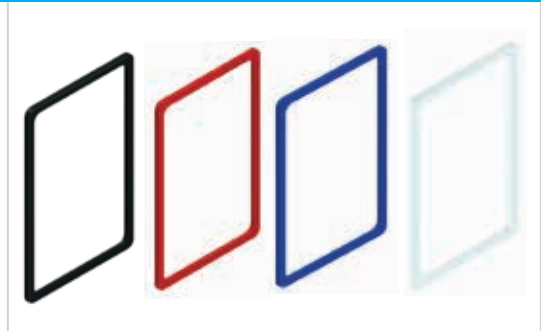

PVC TICKET FRAME INSERTS

Simply slide your artwork in-between 2 x PVC sheets before inserting it into a ticket frame to protect it for years to come.

Clear

Pack Qty	1
Sizes Available	A3, A4, A5

TF-PVC



T-PIECE CONNECTORS

Use T-pieces connectors to attach a stem and base to your ticket frame. Clip the T-piece onto the ticket frame then insert a stem into the other end of the T-piece. Place the T-piece on the long edge of your frame for landscape orientation or clip it to the short edge to display a portrait frame.

Black
 Red
 Blue
 White
 Clear

Pack Qty	1
Suits	10mm Ticket Frames & 10mm Stems

TF-TC



TICKET FRAME BASES

Bases attach to ticket frame stems to stand frames upright. A variety of styles and sizes are available. All made from metal for longevity.

Black
 Red
 Blue
 Grey

Pack Qty	1	
Code (SKU)	TF-MBASE	TF-ABASE
Size (mm)	180 x 160	200 x 160
Colours	Black, Blue, Red	Grey

TF-MBASE / ABASE

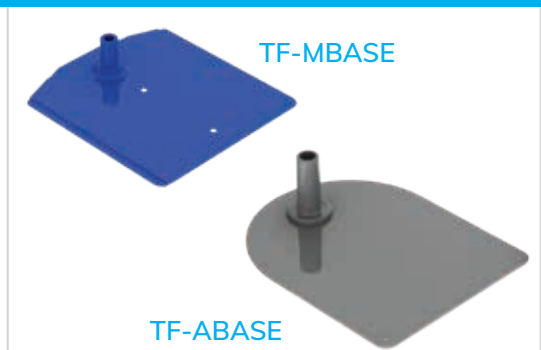

TICKET FRAME STEMS

Stems attach to T-piece connectors on one end and a base on the other end for adding ticket frames. Choose from fixed or telescopic stems depending on the location of the product being promoted in the ticket frame.

Style	Code (SKU)	Sizes / Details
Fixed	TF-STEM	Fixed chrome stem available in 50, 150 or 300mm heights
Telescopic	TF-TELE-A500	Silver aluminium stem adjusts from 310-550mm
	TF-TELE	Telescopic post available in black or chrome. Adjusts 200-600mm
	TF-TELE-LG	Telescopic stand including base, stem and T-piece connector in black or white. Includes a 230mm wide base (320mm also available separately). Adjusts from 600-1400 high

TF-STEM & TF-TELE

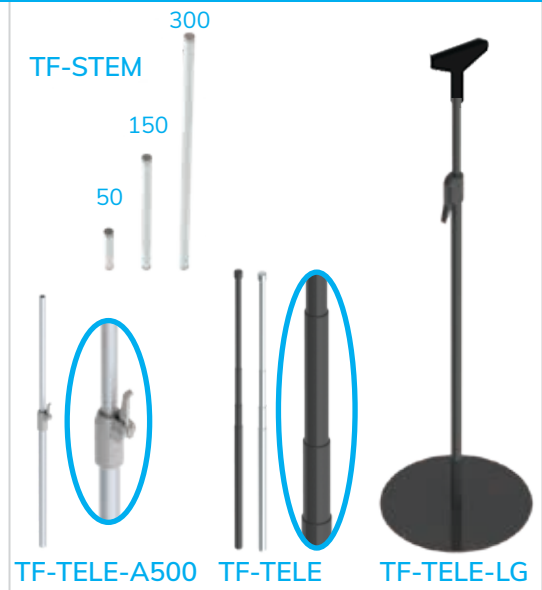

TICKET FRAME ACCESSORIES

Stand ticket frames up with feet, hang them with hooks or attach to a surface with an adhesive base. The possibilities are endless.

Clear

Item	Code (SKU)	Use
Adhesive Base Clip	TF-AB-CL	Fix your ticket frame to a certain location with an adhesive clip where it will not move or get knocked over
Standalone Feet	TF-FEET-CL	Purchase 2 x feet to create a self standing ticket frame to place on counters or shelves
Hanging Hooks	TF-HANG-CL	Hang your ticket frame using 2 hooks



TICKET FRAME MAGNETIC ATTACHMENTS

Attach ticket frames to metal surfaces using a fixed attachment or hinged version depending on your requirements. The hinged version allows a stem and T-piece to be inserted to extend the ticket frame higher. It also moves forward or backwards, allowing the ticket frame to be placed on an angle whilst the base remains fixed.

Black Red Blue White (Fixed Only)

Item	Code (SKU)	Use
Fixed	TF-MAG	Fix your ticket frame to a metal surface
Hinged	TF-MAG-HG	Attaches ticket frame to a metal surface with different sized stems (50, 150 or 300mm) and can also be moved up or down to angle the ticket frame

TF-MAG



A4 METAL TICKET FRAME KITS

Premium signage system suitable for all retail stores. Kit includes metal A4 ticket frame, stem (adjustable or fixed) and a base. Metal components ensure strength, durability and longevity.

Chrome

Pack Qty	1
Stem Size (mm)	300 to 600 (Telescopic Adjustable), 300 (Fixed Stem)

TF-C-A4PT-T

Telescopic Stem
TF-C-A4PT
-TELE-T

Fixed Stem
TF-C-A4PT
-STEM-T



REUSABLE ADHESIVE TICKET HOLDER

A simple signage solution consisting of a plastic sign holder with two adhesive strips for adding pricing or promotional tickets to flat surfaces. Simply slide the ticket/sign into the holder from the side. Sits flat against the surface for an uncluttered and presentable display. Can be re-used by simply pulling it off the surface and re-applying it elsewhere.

Clear

Pack Qty	10	
Sizes Available	A4, A6	A7
Orientation	Portrait	Landscape

SH-RATH

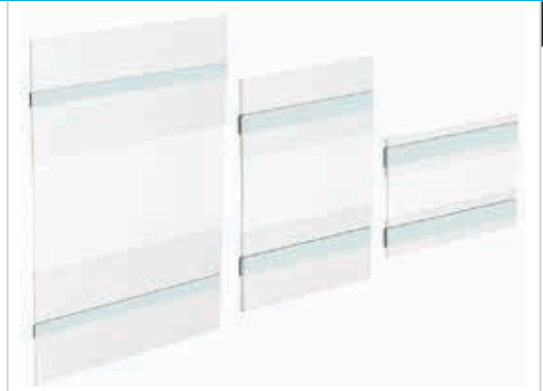

T-GRIP SIGN HOLDERS

A range of T-grips are available to suit all requirements. Available in heavy duty for large corflute/aisle signage, hinged T-grips for flexibility and slim T-grips for posters. T-grips can attach to any surface with its strong and durable Avery adhesive tape.

Clear

Pack Qty	25			
Styles Available	A Hinged	B Fast Grip	C Heavy Duty	D Slim
Code (SKU)	SH-STGV75-HG	SH-STGV75	SH-STGV75-HD	SH-TGV25 & SH-TGV75
Lengths (mm)	75			25, 75

SH-STGV

A Hinged 75mm

C Heavy Duty 75mm

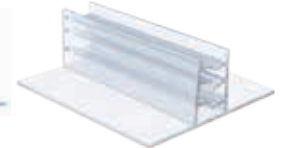

D Slim 75mm

B Fast Grip 75mm



D Slim 25mm



EASY CLIPS

Easy clips are a versatile and easily maneuverable signage solution. These clips are ideal to display smaller signage and promotional tickets. Ball sockets enable the clip to swivel around to any desired position. Simply clip your tickets directly into the plastic holders.

Clear

Pack Qty	5	
Style & Code (SKU)	Clip (SH-SW002)	Clamp (SH-SW007)
Size (mm)	65 x 25	102 x 77

SH-SW00



Clip Style
SH-SW002



Clamp Style
SH-SW007

MAGNETIC AISLE SIGN HOLDER (L-SHAPE)

SH-AISH-MAGL

The L-Shape magnetic sign holder kit includes a magnetic base and a plastic grip strip (300mm long) to hold and protect your poster. It can be used for many applications and holds posters vertically or horizontally. The grip strip supports corflute or thick cardboard materials (1-3mm) whilst the L-shape magnetic base can be used individually for corflute/card 1-5mm thick.

Black White

SH-AISH-MAGL	Code for singular magnetic base
SH-AISH-MAGL-T	Kit code for magnetic base + grip strip



MAGNETIC AISLE SIGN HOLDER (420MM ARM)

SH-AISH-MAG420

Includes two adjustable hooks which slide along the pole to hold a variety of different sized signs. Simply punch holes into your poster and slide the hooks along the arm to adjust them to the width of your poster. Hooks will accommodate signage up to 3mm thick. The arm moves a full 180 degrees and locks into position so that the magnetic base can be set vertically or horizontally to fit a wide range of displays and shelving.

White

Pack Qty	10
One Size Suits (mm)	Poster/Corflute up to 420 Wide



SNAP FRAMES

PF-SL

Snap frames are a simple yet cost-effective way to professionally display your promotions or events in-store and can be placed in portrait or landscape positions. Once fixed to your wall, artwork can be easily changed by simply snapping open the frames edges. Clear perspex (included) helps protect artwork. Featuring two styles, snap frames can be magnetically fixed to gondolas (magnetic tape sold separately).

Silver

Pack Qty	1	
Styles	Square Edges	Rounded Edges
Sizes Available	A1, A2 A3, A4	A0, A1



FLOOR STANDS

ACRYLIC CATALOGUE STAND

Catalogue stands are a stylish way to display catalogues, leaflets or pamphlets. Acrylic catalogue stands are available in portrait A4 or A3 display sizes and include an attached sign holder in the same size for signage to be easily be changed as required.

Black Chrome

Display Sizes	A4 Portrait or A3 Portrait
Size (mm)	295 Base Diameter x 900 Pole Height

FD-CATST900R-T



WIRE CATALOGUE STAND

Wire catalogue stands require no cleaning as they do not collect dust. They are available in either black or white and include an A4 portrait display basket with an A4 portrait acrylic sign holder.

Black White

Display Size	A4 Portrait
Size (mm)	355 Base Diameter x 720 Pole Height

FD-CATST-W



A1 BULLETIN SIGN HOLDER

A new and stylish bulletin sign holder includes an optional A3 brochure holder which attaches to the front of the stand, inviting customers to collect a catalogue or brochure. Made from strong metal tubing with a semi-gloss, black powder coating, it also includes a pair of A1 acrylic inserts to prevent any damage to your artwork.

Black

Pack Qty	1
Size (mm)	A1 Portrait Frame, A3 Landscape Brochure Holder. Total Height: 1702mm

FD-BSH-BK-A1



A1 HEAVY DUTY OUTDOOR SIGN HOLDER

Strong and durable to withstand weather events, this outdoor display features an A1 portrait metal snap frame with rounded corners for inserting artwork. The frame attaches to a heavy duty base that can be filled with water or sand to provide extra stability in windy conditions. The base also features built in wheels for easy maneuverability.

Silver Frame Grey Base

Pack Qty	1
Includes	2 x PVC Artwork Covers, 1 x A1 Snap Frame, 1 x Heavy Duty Base With Wheels & Handle

FD-OD-HDSH-A1



SNAP FRAME FLOOR DISPLAY SIGN HOLDER

FD-SL25A4

Features an aluminium A4 snap lock frame, stainless steel pole/base and adjustable height stem (800-1250mm). Can be used in both portrait or landscape positions with its ball rotation, swivel function.

Chrome

Pack Qty	1
Display Size	A4 Snap Frame



A-FRAME

PF-SLLPB204

This self-standing, double sided sign is the perfect solution for grabbing the attention of passers-by. Artwork can be easily changed by simply snapping open the frames edges. The A-Frame folds up for easy moving, while clear perspex covers (included) protect artwork. Suits A1 portrait artwork each side (594mm W x 840mm H).

Silver

Pack Qty	1
Artwork Insert Size (mm)	A1 (594 W x 1108 H)



COUNTER/CHECKOUT POS

MULTI-RACK COUNTER STAND

ST-MRW

Multi-rack display stands are the perfect solution to counter top displays. They are ideal to display small products, jewellery, beauty accessories, key rings, sweets and more. Includes six hooks. The display also features two rings at the top to hold signage.

Black White

Pack Qty	1
Size (mm)	280 H x 270 W (Hooks 100mm long)
Includes	Stand with 11 x usable wires, 6 x plastic hooks and 2 x rings to hold signage

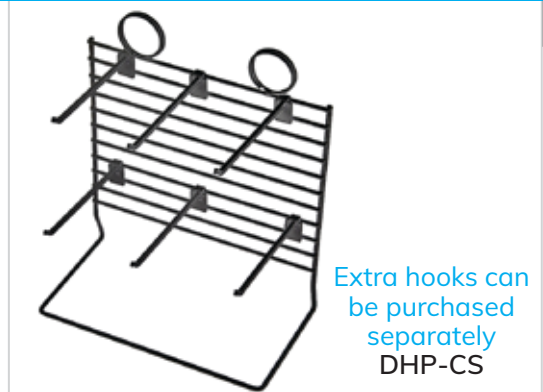

SHOPPING BAG DISPENSER

BB-SBD

Ideal for grocery and convenience stores, the shopping bag dispenser has a solid design, with a sturdy base, handles and bag tab. It can be screwed into the counter or hung from hooks and fits most small reusable bags.

Chrome

Pack Qty	1
Size (mm)	310 W X 350 H



HANGING SIGNAGE

CEILING GRIPS

Ceiling grips are perfect for creating eye catching displays that hang from the ceiling. The plastic ceiling hanger (A) and wire squeeze clip (D) clips around suspended ceiling strips and can easily be moved without roof damage. The adhesive grip (B) simply adheres to any surface for hanging items. The round magnetic hook (C) is great for hanging signage from metal beams and is capable of holding up to 2.5kg per hook. See below to add fixed or extended ceiling hangers as well as poster grips to display your signage.

Pack Qty	10			
Colour	<input type="checkbox"/> White		<input type="checkbox"/> Zinc	
Styles	A Ceiling Hanger	B Adhesive Grip	C Round Magnetic Hook	D Wire Squeeze Clip
Code (SKU)	HDA-PSC	HDA-AFIX	HD-RHP	HDA-WSC
Size (mm)	22 H	20 H x 20 W	36 D	75 H

HDA



A Ceiling Hanger



B Adhesive Grip



C Magnetic Hook



D Wire Squeeze Clip

CEILING HANGERS

Hang poster grips from ceilings with wire ceiling hangers. Adjustable ceiling hangers (210mm-1500mm) allow you to specify hanging heights while fixed length ceiling hangers allow for easier installation to ensure all of your posters hang at the same height.

Silver

Pack Qty	1
Styles	Fixed or Adjustable
Sizes Available (mm)	100, 150, 200, 300, 400, 600, 900 (Adjustable is 210-1500mm)

HDA-CHK/EHK



POSTER GRIPS

Hang posters easily from wire ceiling hangers with plastic or aluminium poster grips. Each poster grip snaps open and shut to grip your poster. One poster grip includes a top and bottom piece, ideal for high ceilings to utilise empty space or to easily highlight sections for customers. Includes eyelets to attach ceiling hangers (sold separately above).

Silver (Aluminium) Clear (Plastic) Black (Plastic) 1220 L Only

Pack Qty	1 Pair (Includes Top & Bottom)
Poster Grip Lengths (mm)	610, 850, 1220 (Aluminium) 610, 850, 1220 (Plastic)

HD-PH



Plastic

Aluminium

FASTLOAD CLIP STRIP

CS-PMF12

The fastload clip strip is the quickest and easiest locking clip strip to load. The ridges lock products in place while making it easy to apply hanging items. Sturdy plastic strip which includes space at the top to attach a label for pricing items hanging on the clip strip. Add Strip Hooks (S-hooks, see below) to hang clip strips.

Opaque

Pack Qty	10
Size (mm)	33 W x 610 L
Number Of Clips	12

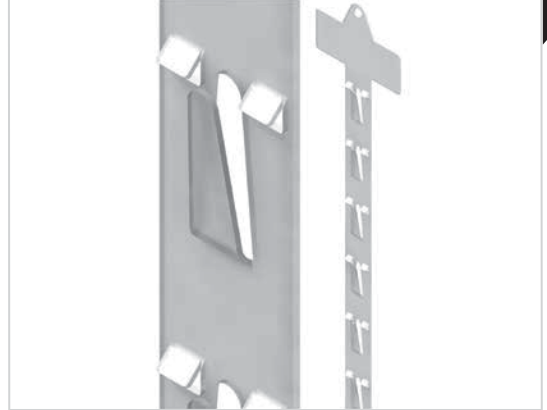

MOULDED HANGSELL CLIP STRIP

CS-PML12

An economical clip strip which can be used anywhere to hang your merchandise. Small teeth help keep products in place. It holds up to 12 items and includes space at the top to attach a label. Strip hooks (S-hooks) below can be used to hang clip strips.

Clear White

Pack Qty	10
Size (mm)	33 W x 590 L
Number Of Clips	12



S-HOOKS

CSA-SHK

With 3mm wire thickness, S-hooks are the perfect solution for hanging clip strips, signage and other products from your gondolas.

Zinc

Pack Qty	25
Heights (mm)	25, 50



BROCHURE HOLDERS

BROCHURE DISPLAYS

These affordable and stylish brochure holders can be used on a counter or mounted to a wall by inserting screws into the holes provided. They are ideal for catalogues and magazines in A4 or DL size.

Clear

Pack Qty	1		
Sizes Available	A4 or DL (1 level portrait only)		
Levels Of Display	1	3	4
Orientations Available	Portrait	Portrait & Landscape	Landscape

CD-A4 & CD-DL

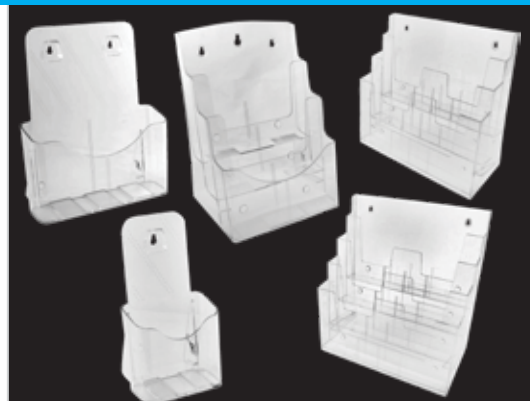

BROCHURE HOLDERS

Two different styles of A4 portrait brochure holders are available. One style includes clips on the holder to add multiple levels by clipping them together. The second style (Flatback brochure holders) can be attached to pegboard or slatwall with the use of a wire connector (sold separately below WDA-BPW). Both styles can become free standing with the use of a base bracket (CDA-BWA) which is also sold separately below.

Clear

Pack Qty	1	
Styles	A Clip Together	B Flatback
Code (SKU)	CD-EA4AC	CD-EA4A

CD-EA4 / CD-EA4A

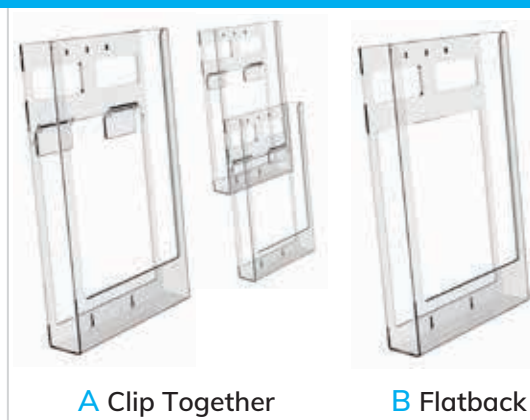

BROCHURE CONNECTOR (WIRE)

A simple wire bracket/connector which allows brochure holders to be attached to pegboard or slatwall by inserting the wire connector through the holes on the top of the brochure holder and then into the panel.

Chrome

Pack Qty	1
Size (mm)	70 W

WDA-BPW

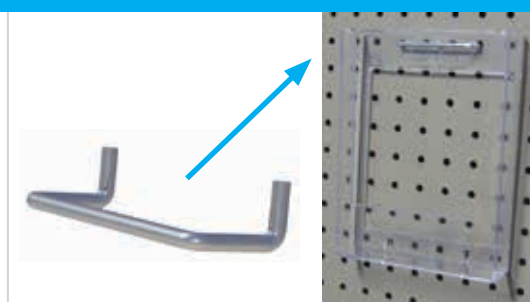

CLIP-ON BASE FOR BROCHURE HOLDERS

An acrylic base used to create free standing brochure holders that can be placed on counters, shelves or tables. Simply connect the base to any flatback or clip together brochure holders above.

Chrome

Pack Qty	1
Size (mm)	80 L x 100 W

CDA-BWA



SHOPPING BASKETS

SMALL & LARGE SHOPPING BASKETS

Shopping baskets provide convenience for your customer and are a cost-effective way to encourage additional purchases! Keep your customers shopping longer by positioning baskets near the entryway. A shopping basket stand is also available (sold separately under code BB-BASTL - see below)

Black
 Red
 Blue (28L Only)

Pack Qty	10
Small Size (mm) - 21L	290 W x 425 L x 225 H
Large Size (mm) - 28L	330 W x 480 L x 260 H

BB-BAL

21 L



28 L



SHOPPING BASKET ACCESSORIES

Shopping baskets aren't complete without their stand (to keep all of the baskets in one place) and sign holder (to help customers locate the basket stand). Purchase a sign for your sign holder which reads "SHOPPING BASKETS FOR YOUR CONVENIENCE. Please return to checkout". The sign holder (B) suits the stand (C) which features wheels for easy maneuverability. The basket holder (D) is a simple and affordable alternative to the basket stand.

Chrome

Accessories	A Sign	B Sign Holder	C Stand	D Holder
Code (SKU)	BB-BAC	BB-BAST-SH	BB-BASTL	BB-BH-CH

BB-BA

A Sign Card



B Sign Holder



C Stand



D Holder

ROLLER SHOPPING BASKETS 43L

Roller baskets are lightweight, easy to manoeuvre and encourage customers to purchase more as they are less restricted by weight. They include an adjustable pull-up handle to wheel the basket and a standard handle to carry the basket. Large 50mm wheels allow for effortless mobility, even when full. Stackable for convenient storage.

Black
 Red
 Blue

Pack Qty	1
Size (mm)	380 W x 530 L x 442 H

BB-BAR43



SLATWALL

Slatwall is one of the most popular panel backings available today. It consists of 100mm panels with 10mm grooves stacked together to form a wall. SI Retail stock a huge variety of Slatwall displays and accessories such as brackets, signs, shelves, arms, hangrails, hooks and acrylic displays.

Customers can select our free standing Slatwall spinning tower which is ideal for small store spaces and assists in helping you find the best impulse location within your store. The benefit of Slatwall display stands is that they can be easily configured with a wide range of accessories including wooden or acrylic shelves, display hooks, signage and hanging fixtures such as merchandising arms, rails and organisation tools like Slatbox containers or brochure holders. It's never been so easy to create eye-popping shop displays!



SLATWALL SPINNING TOWER

DC-SW-TOWERS-460WT

Perfect for small in-store spaces, the slatwall spinning tower is a high quality solution which can be used to display a variety of hanging items. It consists of standard 100mm high slatwall panels (fits slatwall hooks) and includes protective rubbers on the base to prevent any scratches to your floor. In addition to being smooth and easy to spin, it is also very quick and easy to set-up! This space-saving tower can display hangsell products on all four sides, making it a perfect addition to your store. Add a self-standing ticket frame to the top and hooks with label holders for a complete solution (accessories sold separately).

White

Pack Qty	1
Material	MDF
Size (mm)	460 W x 460 L x 1360 H



BRACKETS, SIGNS, SHELVES & ARMS

BRACKETS FOR MELAMINE SHELVES

SW-BS

Brackets to hold melamine shelves onto slatwall. To be used with shelf grommets (sold separately, see page 18). Centre grommets (WSA-CEN-GR) hold 1 shelf either side of the bracket whilst end grommets (WSA-END-GR) are used to hold the first and last shelf in a row.

Chrome

Pack Qty	2
Material	Metal
Lengths (mm)	200, 250, 300, 350, 400

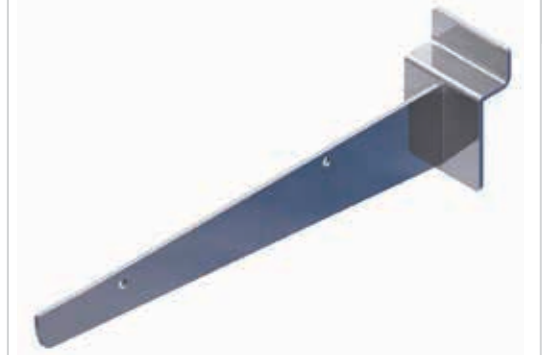

ACRYLIC SIGN HOLDER FOR SLATWALL

SW-ASH-MA

Available in 3 different sizes, this acrylic sign holder allows you to insert artwork and display it on a slatwall panel.

Clear

Pack Qty	1
Orientation	Portrait
Artwork Sizes	A4, A5, A6



SMALL ACRYLIC SHELF

SW-ASD

High quality acrylic shelf. Shelf fits into standard slatwall panels. No brackets or grommets are required.

Clear

Pack Qty	1
Material	Clear Acrylic
Size (mm)	100 W x 250 L



SMALL ACRYLIC SHELF WITH LABEL SPACE

SW-ASD300SH

High quality acrylic shelf for displaying a variety of small items. Includes a facing on the front to add pricing information. Simply slide the label in from the side. Fits into standard slatwall panels. No brackets or grommets are required.

Clear

Pack Qty	1
Material	Clear Acrylic
Size (mm)	100 W x 300 L x 300 H



SQUARE STRAIGHT ARM

SW-S

A cost effective way of hanging garments onto a slatwall display. Arm features a notch at the end to ensure product doesn't fall or slide off.

Chrome

Pack Qty	1
Lengths (mm)	300, 400



SQUARE WATERFALL ARM

SW-WS

A cascading arm available with 6 pins (400mm length) or 9 pins (500mm length).

Chrome

Pack Qty	1
Size (mm)	400 (6 pins) 500 (9 pins)



HANGRAILS & ACCESSORIES

HANGRAIL

A hangrail that fits into slatwall panels to hang garments or to add a 300mm deep shelf.

Chrome

Pack Qty	1
Material	Metal
Lengths (mm)	600, 900, 1200

SW-HR12

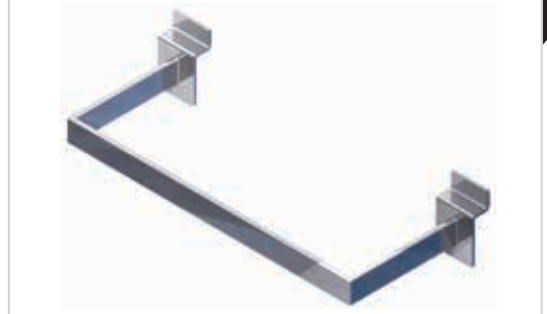

HANGRAIL GLASS SHELF BRACKET

A bracket which is placed into the slits provided on the slatwall hangrail (SW-HR12 above) to hold glass shelves on the hangrail. Two shelf brackets are required per side of hangrail meaning a total of four brackets are required per hangrail to hold one shelf on the hangrail.

Chrome

Pack Qty	4
Material	Metal with Rubber Suction Cup

SF-HR12SFG-BKT



HANGRAIL MELAMINE SHELF BRACKET

A bracket which is inserted into the two slits provided within the slatwall hangrail (SW-HR12 above) to hold melamine shelves on the hangrail. Two shelf brackets are required per side of hangrail meaning a total of four brackets are required to hold one shelf.

Chrome

Pack Qty	4
Material	Metal

SF-HR12SFM-BKT



SLATBOX STORAGE

Slatbox containers are a strong and versatile storage system comprised of different sized and shaped bins that are designed to fit into all major slotted wall systems. They provide retailers with the ability to organise their store and products to make it more appealing to customers; and are a great solution for organising and separating smaller or difficult to arrange products which may not have any hangsell ability.

Slatbox storage containers are easy to assemble and take down, making them perfect for temporary displays or for spaces where product ranges change often. They are great for all areas and have a place within every industry. From day-care centres, hospital supply rooms, confectionery stands, fishing tackle stores and everything in-between. Slatbox storage containers can also be used on pegboard displays with the use of a pegboard adapter or on grid wire/mesh with the use of a grid adapter.

Slatbox offer a large array of different styles and sizes to cater to your every need. A truly versatile product range for a variety of applications.

STORBOX

SW-SB

Opaque



Style	Size (mm)	Weight Limit
Standard	115 L x 140 W x 85 H	15kg
Wide	115 L x 290 W x 85 H	30kg
Cube	150 L x 150 W x 178 H	30kg
Big	275 L x 275 W x 170 H	30kg

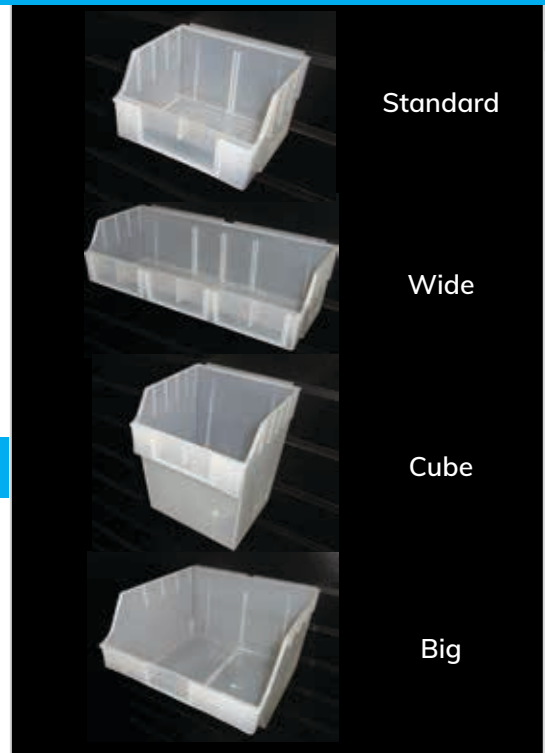

Standard

Wide

Cube

Big

STORBOX DIVIDERS

Style	Code & Size	Image	Suits/Fits
Small Divider	SW-SB-DIV-02A 100 L x 80 W x 2mm Thick		Storbox Standard & Wide
Large Divider	SW-SB-DIV-02C 260 L x 165 W x 4mm Thick		Storbox Big

HOBIBOX

SW-SB

Opaque



Style	Size (mm)	Weight Limit
Small	109 L x 114 W x 75 H	9kg
Long	198 L x 114 W x 75 H	5kg

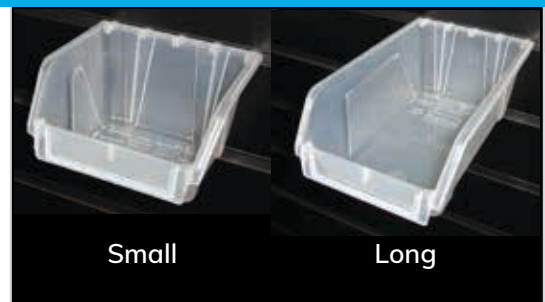

Small

Long

POPBOX

SW-SB

Opaque



Style	Size (mm)	Weight Limit
Standard	130 L x 140 W x 100 H	15kg
Cube	170 L x 140 W x 180 H	30kg
Big	357 L x 280 W x 170 H	30kg
Jumbo	350 L x 565 W x 170 H	25kg

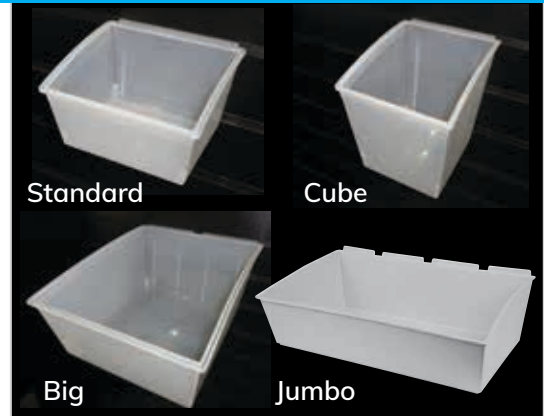

SHELFBOX

SW-SB

Opaque



Style	Size (mm)	Weight Limit
100	130 L x 140 W x 85 H	15kg
200	225 L x 140 W x 85 H	22kg

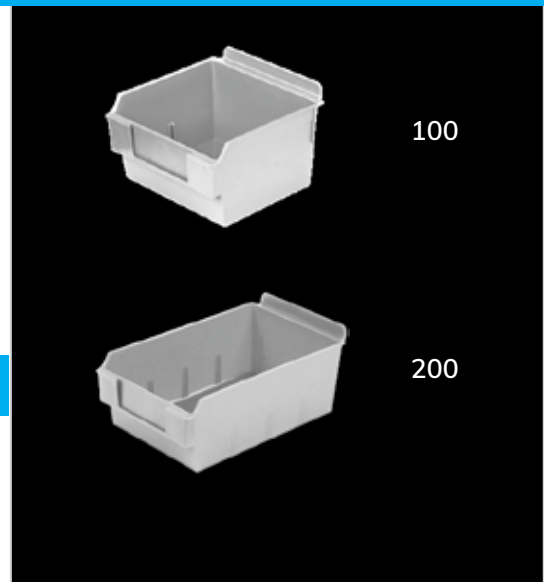

SHELFBOX DIVIDER

Style	Code & Size	Image	Suits/Fits
Shelf Divider	SW-SB-DIV-02A 130 L x 70 H x 2mm Thick		All Shelfbox

SLATBOX ADAPTERS

ADAPTERS

SW-SB-03

Adapters allow you to connect slatboxes to Grid Mesh or Pegboard. The Grid adapter is suitable for all common mesh sizes such as 25, 50, 75mm or anywhere a box can be hung over a top edge (up to 6mm thick). For BIG variations of slatbox, 2 x adapters are required per box.

Zinc

Pack Qty	1	
Styles	A Grid Adapter	B Pegboard Adapter
Suits	Storbox, Popbox, Hobibox	Storbox, Popbox



GARMENT RACKS

Garment racks are one of the most popular methods of displaying clothes and creating head-turning shop displays. We offer a range of high quality and affordable garment racks to suit any retail store that stocks apparel as part of their product range. Choose from mobile salesman racks, heavy-duty clothes racks, or for smaller store spaces, opt for 2-way or 4-way clothes racks with your choice of straight and/or waterfall arms.

These versatile garment racks are designed to be easily maneuverable; making them the perfect solution to display clothing for either permanent or temporary displays (whether in-store, at markets, or for any other fashion focused event). With a sleek and modern design, SI Retail's garment racks are made from high quality materials and will last for years to come. They come flat-packed and are very easy to assemble.

Try grouping items by colour, as this is visually appealing to customers. Alternatively, if you're using tiered racks, another way of increasing sales is to cross merchandise garments. This gives customers a better idea of how they can put an outfit together using your products.



MOBILE GARMENT RACKS

Collapsible salesman racks are available with either a single or double rail (black only available in single rail option). Included heavy duty castor wheels make the mobile racks great for specials, temporary displays, markets and events. They are quickly disassembled and reassembled for transportation and storage. Height and rail lengths can be adjusted to create additional hanging space.

Chrome (1 or 2 Rails) Black (1 Rail)

Pack Qty	1	
Styles	1 Rail	2 Rails
Code (SKU)	GR-MOBILE	GR-MOBILE-2R
Adjustable Height (mm)	1420 - 1650	1310 - 1560

GR-MOBILE



Black 1 Rail
GR-MOBILE-BK



Chrome 2 Rails
GR-MOBILE-2R

HEAVY DUTY Z-RACK

The black heavy duty Z-Rack is ideal to display heavy or long clothing and garments. It is perfect for department stores, sport and fashion shops or even industrial laundry or scuba diving equipment. This rack folds for easy storage and transportation, and comes with lockable, heavy-duty wheels for easy mobility.

Black & Chrome

Load Capacity	150kg
Size (mm)	1800 H x 1600 L x 600 W

GR-Z-RACK-BK



2-WAY RACK

These 2 way racks are ideal to display clothes in small retail spaces. It features an adjustable height to create layered clothing displays, along with 2 arms for merchandising. Choose either 9 pin waterfall arms, straight arms or a combination of both.

Chrome

Adjustable Height (mm)	1200 - 1800 (75mm Increments)
Base Size (mm)	300 L x 380 W

GR-2



4-WAY RACK

The 4 way clothes rack is ideal to display clothes at 4 angles to maximise the use of your floor space. It is height adjustable to create layered clothing displays and includes 4 arms for merchandising. Choose either 9 pin waterfall arms, straight arms or a combination of both.

Chrome

Adjustable Height (mm)	1200 - 1800 (75mm Increments)
Base Size (mm)	860 L x 860 W

GR-4



GARMENT RACK SIGNAGE

SCREW IN SIGN HOLDERS

A classy sign holder for use on 2-way and 4-way garment racks. It simply screws into the dedicated sign holder holes. They include acrylic to protect artwork.

Clear Acrylic with Chrome Accent

Pack Qty	1
Sizes	A4, A5
Orientation	Portrait
Stem Lengths (mm)	50, 150

GRA-SHM



CUSTOM CAPABILITIES

Now it's easy to enhance your in-store environment with custom branded fixtures and fittings without the barriers that arise from sourcing out of China. SI Retail offers in-house industrial design for all custom-made shop fitting requirements. Australia's leading retailers utilise SI Retail's design services and endless manufacturing capabilities (in metal, acrylic, fiberglass, joinery/wood, plastic, aluminium and glass) to obtain unique product or merchandising solutions relative to their goals.

From the initial brief of a product, to its design and prototyping, development, production, packing, quality assurance and finally logistics, we have the solutions, suppliers and experience to take care of your custom project and the entire process involved!

AUTO WOOD ROUTING



AUTO WOOD TRIMMING



CHROME PLATING



ACRYLIC LASER CUTTER



METAL LASER CUTTER



METAL PUNCHING



METAL SHEET BENDING



METAL V CUTTER



PLASTIC EXTRUSION



TUBE BENDING



WIRE MESH PRODUCTION



WOOD EDGE DRILLING



CUSTOM FIXTURES - FULL STORE FIT OUT

(Over 200 Items Designed & Made To Order For Rebel Sports)



CUSTOM SHELVING

(Designed & Made To Order)

INTEGRATED RACKING

Perfect for wholesalers or retailers who require storage above gondolas. The integrated racking system combines heavy duty back of house racking with our Versa style of gondolas for the best of both worlds. Display products on the shelves then store stock directly above the gondolas in cartons or pallets. This extra heavy duty shelving system solves the age old problem of needing storage space and is offered in two formats. One format consists of two single-sided units back to back with a spacer in-between (far right image) whilst the other format is comprised of a double sided unit with no spacer (far left image).

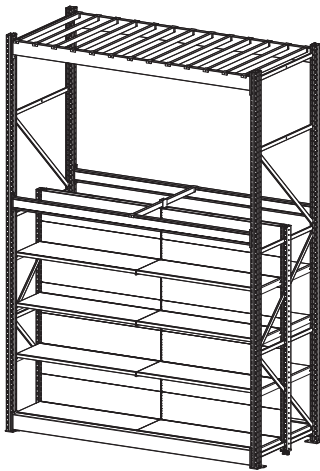

LONGSPAN RETAIL FLOOR SHELVING

Simple longspan shelving made to order. Signage was required to showcase aisle contents. Our solution incorporated an extension from the top of the racking with an optional category header sign.



RETAIL/BACK OF HOUSE DIVIDER WALL

Since the rear of your store isn't seen by customers, a standard and economical longspan racking system is recommended. This type of racking can be set up in a small amount of time. The custom divider wall below was designed to attach to a longspan system and separate retail space from back of house operations. By integrating longspan racking with the divider, no floor space was lost yet stock could still be displayed with the use of crossbars mounted to the retail side.



AISLE FEATURE DENSE END

A dense end designed to finish off an aisle of gondolas. Our design features display shelves that can be positioned either flat or on an angle. The design incorporates a sign holder for the ability to insert header cards for promoting specials, brands or aisle category contents.

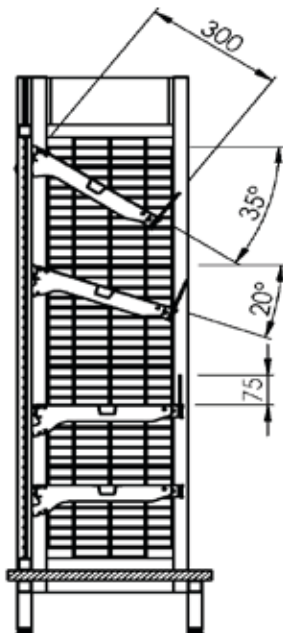

CUSTOM DISPLAYS

(Designed & Made To Order)

ROUND BASKET

A basket designed to attach to shelving for displaying a handful of small items, easily accessible to customers. This design includes a flip scan label holder to display pricing and product information.



ACRYLIC COUNTER DISPLAY

This simple yet effective counter confectionery display was created to sit on top of a counter at the purchase point for maximum impact and temptation!



IMPULSE WIRE DISPLAY UNIT

This custom impulse display was designed to take up minimal floor space whilst displaying both hangsell and shelved products. It features curved baskets with wire fences and dividers plus a panel of grid mesh for hangsell.



SPINNING HANGSELL DISPLAY

A spinning mobile impulse stand allowing for 15 pegboard hangsell facings. Perfect for displaying impulse items near the counter. It also includes an extra detachable panel which fits onto the top of the stand to display larger items.



FRAGRANCE CABINET

A cabinet featuring glass shelves and a lockable glass front door. By adding LED's and a big sign holder, higher priced fragrances can be easily seen but not easily touched. This helps prevent theft or breakage of valuable items.



UMBRELLA STAND

Just for umbrellas, this stand was designed to store and display a large selection of umbrellas within a small space.

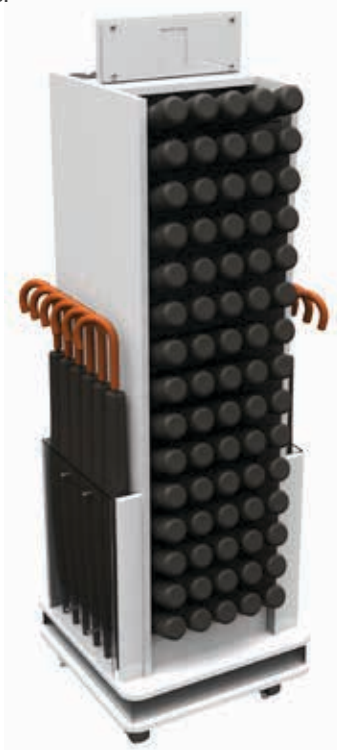

WINE TASTING BENCHES

Creating displays for retailers is our specialty. The below designs feature a wine display bench and a wine tasting bench. Made from high quality timber and metal with large signage to attract attention.



MOBILE APPAREL DISPLAY

One of our customers required a mobile display to showcase their apparel. They wanted to be able to move it around to find the best position for increasing sales.



SECURITY CAMERA DISPLAY

This custom display was designed to showcase the brand and promote the quality of the security camera by allowing customers to see the recording live in store.



MERCHANDISING TROLLEY

This custom merchandising trolley was designed to allow staff to re-merchandise the retail floor without having to carry multiple items back and forth. It features baskets to hold bigger items, large drawers for posters, tickets and signage, a metal tray for pens/paper and accessory dividers on the top. It also includes a large space to hold data strips and a holder for rubbish bags. Everything you need to keep your store looking its best can now be placed in one mobile trolley and moved around the store with ease.



KNEE PAD DISPLAY

We designed this knee pad display for a local motorcycle accessories retailer. It can be attached to their Slatwall panels for displaying their knee pads on the gondolas.



ADJUSTABLE 2 TIER STAND

This custom piece was designed for the petrol and convenience industry to maximise their impulse sales. Taking up little floor space, the adjustable stand comprises of two baskets which can be moved up or down on the pole as required. It also features a frame for artwork to be easily inserted. Perfect for holding chocolate bars and potato chips, this stand allows products to really stand out and provides easy access for the consumer to grab items from each basket.

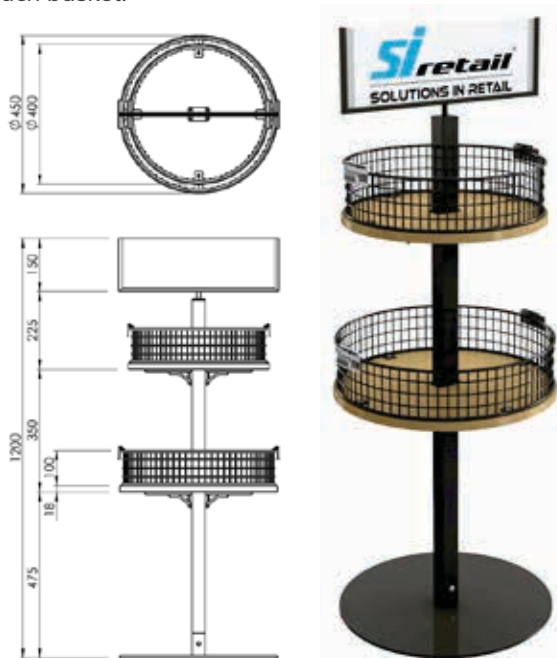

WING ENDS

Designed with the pharmacy industry in mind, wing ends attach to a classic 1500mm high end bay to add extra merchandising space on each side of the bay. Place grid mesh hooks on the wire wings to hang product on the sides of each end bay. Optional sign panels could be added to brand or categorise each side of the wing end. The wing size was designed at 1250mm high x 300mm deep x 100mm wide with sign panels holding 1250mm high x 100 wide artwork.



CAR ACCESSORIES DISPLAY

A custom display to suit pegboard gondolas was designed for a client to advertise their range of car accessories and allow customers to touch and feel the product.







EZI-Q[®], EZI-GLIDE[®] and DIVIDE-IT[®]
are all registered trade marks of
Fuller Family Holdings Pty Ltd.

 Head Office/Showroom
85 Burchill Street,
Loganholme, QLD, 4129.

 (07) 3801 0000

 (07) 3801 0022

 Melb. Office/Showroom
5 Scholar Drive,
Bundoora, VIC, 3083.

 info@siretail.com

 siretail.com